



Installation and operating manual

OIL-Check 400

**Measuring system for recording
vapour and gas-containing
hydrocarbons in compressed air**



CS Instruments GmbH & Co. KG
Zindelsteiner Straße 15
D-78052 Villingen-Schwenningen
Tel. +49 7705 97899-0
www.cs-instruments.com

Issue date: 08/2021

Version: V1.2

Table of contents

Table of contents.....	3
1 General	5
1.1 Pictograms and symbols	6
1.2 Signal words according to ISO 3864 and ANSI Z.535	7
1.3 General safety instructions	8
1.4 Residual risk	12
1.5 Intended use	13
1.6 Legal warranty and liability for defects	14
2 Transport and storage.....	15
3 Product information and device description	17
3.1 Type plate	17
3.2 Product view	18
3.3 Functional description for OIL-Check 400	18
3.3.1 Measurement value formation	20
3.4 Operating and display elements	21
3.4.1 LED-Display	21
3.4.2 Operating messages	22
3.5 Parts and components	23
3.6 Pressure reducer for compressed air inlet	25
3.7 Dimensions	26
3.8 Technical data OIL-Check 400	27
3.9 Applied EU Directives and harmonised standards	29
4 Assembly.....	30
4.1 Safety instructions	30
4.2 Fundamental requirements for the installation	33
4.3 Wall mounting	35
4.4 Device connections	36
4.5 Assembly of compressed air connection	37
4.5.1 Sampling	37
4.5.2 Connection to the compressed air system	39
4.6 Electrical installation	42
4.6.1 Safety instructions	42
4.6.2 Power supply and fuses	45
4.6.3 Terminals for electrical connections	46
4.6.4 Connection terminals for the potential-free contacts	50
5 Commissioning.....	53
5.1 Initial switching on	54
6 Troubleshooting and remedying malfunctions	59
6.1 Measures in emergencies	59
6.2 Operating messages	59
6.2.1 Exceeding and undershooting the CATALYST temperature	63

- 7 Maintenance and repair works.....64**
 - 7.1 Advance and subsequent preparation for maintenance works 65
 - 7.1.1 Prevention of electrostatic discharge (ESD) 66
 - 7.2 Retaining the protection class with a housing 67
 - 7.3 Maintenance schedule 68
 - 7.4 Calibration intervals 69
 - 7.5 Inspect the pressure regulator for the compressed air inlet 70
 - 7.6 Electrical connection cable defective 71
 - 7.7 Replacing the fuses 72
 - 7.8 Cleaning and decontamination 74
 - 7.9 List of spare parts 75
- 8 Decommissioning and Disposal76**
 - 8.1 Decommissioning 76
 - 8.2 Disposal 76

1 General

The installation and operating instructions for the **OIL-Check 400** measuring device described in this document were developed for the detection of vapours and gaseous hydrocarbons in compressed.

This installation and operating manual for the **OIL-Check 400** measuring device must be carefully read and completely understood by the responsible personnel before starting all work (installation, commissioning and maintenance).

A prerequisite for safe handling and trouble-free operation of this measuring device is compliance with all stated safety instructions and handling instructions.

The operating instructions are an integral part of the measuring device and must always be available at the installation location of the **OIL-Check 400**.

The local accident prevention regulations applicable to the product and the general safety regulations must be complied with.

1.1 Pictograms and symbols

The safety instructions in these operating instructions are intended to prevent hazards. They are located in the operating manual before an action / work / activity is described which can create a hazard.



General hazard symbols (danger, warning, caution).



Warning about electric voltage.



Warning about hot surfaces.



General instructions.



Adhere to the installation and operating instructions.



Wear eye protection



Wear safety shoes.



Wear protective clothing.



Never use water for fire fighting.



Environmentally friendly material.





The packaging material is recyclable. Dispose of it according to the applicable statutory regulations.

1.2 Signal words according to ISO 3864 and ANSI Z.535

DANGER!	Imminent danger Consequences of non-compliance: serious or even fatal injury
WARNING!	Potential danger Consequences of non-compliance: possibly serious or even fatal injury
CAUTION	Imminent danger Consequences of non-compliance: injury and/or damage to property
NOTE	Additional notes, tips and hints Consequences of non-compliance: Disadvantages during operation and maintenance.

1.3 General safety instructions

NOTE	Installation and operating manual
	<ul style="list-style-type: none"> • Before reading, always check whether this installation and operating manual refers to your device type. This document contains important information and instructions for the safe operation of the measuring device. • Before carrying out any work, all specialist technical personnel¹⁾ must therefore have read the installation and operating manual. • A copy of these operating instructions must be kept near the installation location where it is accessible all times. • In addition to the instructions in this installation and operating manual, always comply with the relevant national and statutory regulations for machine operation accident prevention and safety for the respective application. This also applies to the use of accessories and spare parts.

DANGER!	Insufficient qualification
	<ul style="list-style-type: none"> • Incorrect operation with the measuring device can result in serious injury or damage to property. All the activities and tasks described in this operating manual must only be executed by skilled technical personnel. • This installation and operating manual for the OIL-Check 400 measuring device must be carefully read and completely understood by the responsible personnel before starting all work (installation, commissioning and maintenance).

1) Specialist technical personnel

Specialist technical personnel are people who, due to their professional qualification and knowledge in the field of measuring, control and pneumatic technology, and their knowledge of the applicable statutory regulations, guidelines and standards are in a position to independently foresee potential dangers in relation to the use of the device and who are qualified to perform the tasks described in this manual. Special operating conditions (e.g. aggressive media) require additional knowledge.

DANGER!	Electric power
	<p>Touchable conductive parts can lead to dangerous voltages / mains voltage during installation and maintenance or in case of defects. Hazard resulting in of serious or even fatal injury from electric shock when coming into contact with uninsulated parts or mains voltage.</p> <ul style="list-style-type: none"> • All works on the electrical parts of the measuring system may only be executed by appropriately trained skilled personnel. • The measuring device must not be operated when the power supply cables indicate damage or the housing parts have been damaged or removed. • The local valid legal regulations and provisions must be complied with without exception. • Observe the electrical data provided on the rating plate. • Work on the electrical connections may only be executed when the power supply is switched off. The device must be protected against unintentional reconnection or switching on again. • Only utilise components for the electrical installation which have a current approval and are labelled with a CE-Identification Marking. • The wire ends to be connected to the control unit must be equipped with wire-end ferrules. • All electrical connections must be inspected before commissioning and at regular intervals.

WARNING!	Operation of the system outside limit range
	<p>If the specified limiting values are undershot and/or exceeded, then there will be a danger for people or materials and device malfunctions and operation malfunctions could occur as well as incorrect measuring results.</p> <ul style="list-style-type: none"> • The OIL-Check 400 measuring device may only be used in accordance with its intended use and within the permitted limiting values stated on the rating plate as well as in the technical data. • Always adhere to the permitted storage and transport conditions.

WARNING!	Hot surface
	<ul style="list-style-type: none"> • Risk of injury to people property damage - risk of fire! • The CATALYST reference gas generation unit reaches surface temperatures above +60°C during operation. • Always allow the OIL-Check 400 to cool down before executing any work! • Secure and mark the accessible places.

DANGER!	Fire safety
	<p>Any fire developing on the measuring device will result in the highest possible danger levels for people and materials.</p> <ul style="list-style-type: none"> • Safety devices that prevent excessive pressure build-up as a consequence of a fire are not included in the standard scope of delivery. • If there are potential ignition sources at the place of installation of the plant, the operator must take suitable safety measures to ensure that the permissible operating parameters of the plant are not exceeded.

DANGER!	Excessive pressure / temperature
	<ul style="list-style-type: none"> • Suitable measures must be implemented to ensure that the permissible operating pressure and operating temperature are not exceeded in system components. • It is the sole responsibility of the system owner or plant operator to protect the plant against excessive pressure and temperature. • It must be ensured that the pressure generating compressor and the compressed air system are secured and safe. • Suitable measures must be implemented to ensure that the permissible operating temperature is not inadvertently exceeded by ambient conditions at the installation location.

DANGER!	Escaping compressed gas
	<p>Any contact with escaping compressed gas or not secured system parts will create danger of serious injuries or death.</p> <ul style="list-style-type: none"> • Installation and maintenance works must only be executed in a depressurised status. • Only utilise pressure-resistant installation material and suitable tools which are in perfect condition. • Always inspect and re-tighten all plant and system parts before pressurising before pressurising • Open valves slowly to prevent pressure blow in operating status. • The compressed air lines must be permanently installed. • Prevent that people or objects can be hit by escaping compressed gas. • Prevent vibrations, oscillations and impact from being transferred to the measuring device. • Perform a leakage test.

CAUTION	Malfunctions on the OIL-Check 400
	<ul style="list-style-type: none"> • Incorrect installation and insufficient maintenance can lead to malfunctions on the measuring device which will impair the display functions and could lead to incorrect interpretation. • Observe the applicable national regulations, provisions and safety regulations during installation and operation.

1.4 Residual risk

The **OIL-Check 400** measuring system corresponds to the current state of safety technology. Nevertheless, certain residual risks remain:

- Hazards caused by incorrect transport and storage.
- Hazards caused by electrical voltage when using incorrect electrical connection cables or touching live parts with the system open.
- Hazards caused by improper commissioning and/or assembly personnel who are not trained.
- Hazards caused by ignoring the safety instructions.
- Hazards caused by circumventing or disarming the safety equipment or devices.
- Hazards caused by operating outside permissible pressure and temperature limits.
- Hazards caused by operating with a medium other than the approved one.
- The safety labels and/or safety instructions in this operating manual indicate additional residual risks. Always adhere to all safety instructions.

DANGER!	Incorrect installation location
	The OIL-Check 400 must not be installed in explosion-hazardous areas.

1.5 Intended use

The **OIL-Check 400** has been specifically developed for the measuring of hydrocarbon vapours and gases in compressed air. The compressed air must be free of aggressive, corrosive, caustic, toxic and inflammable components.

The residual oil content will be displayed in **mg / Standard m³**. The standard m³ relates to 1.0 bar absolute, +20°C, 0% relative humidity according to ISO 8573-1.

The intended use of the **OIL-Check 400** requires that the instructions in the installation and operating instructions are fully implemented and that the measuring device is only used by **qualified personnel** according to the technical data.

CAUTION	Danger caused by incorrect use
	<p>Operate OIL-Check 400 only for the intended purpose and within the limit range specified in the technical data. Do not operate the unit with any media (fluids, gas/vapour mixtures) other than those listed above. Any other use of the device, which exceeds the intended use, is hereby deemed to be improper and can cause a hazard for the safety of people and the environment.</p> <ul style="list-style-type: none">• The OIL-Check 400 may only be pressurised with compressed air medium.• The device is not suitable for operation in explosion hazard areas as well as in areas with aggressive atmospheres.• The measuring device must not be exposed to direct sunlight or heat radiation.

1.6 Legal warranty and liability for defects

All liability claims will be invalidated as soon as the **OIL-Check 400** is not utilised in accordance with its intended use or is operated outside the limits specified in the technical data. The following particularly apply:

- Technically incorrect installation, incorrect commissioning, incorrect maintenance or incorrect operation
- Operation with defective components
- Non-compliance with the instructions in this manual, in particular the safety instructions
- Execution of constructive interventions or modifications on the device
- Non-compliance with the prescribed maintenance intervals
- Utilising non-original or unapproved spare parts for repair and maintenance works.

2 Transport and storage

The **OIL-Check 400** is packaged as transport secure and delivered. Despite our best efforts regarding packaging etc., the device might be damaged during transport. Upon receipt, you must therefore remove all packaging material and inspect the **OIL-Check 400** for visible damage. Any damages must be immediately notified to the transport company and CS Instruments GmbH & Co. KG or one of their agents.

CAUTION	Damage caused during transport or storage
	<p>Incorrect transport or storage can cause damage to the device.</p> <ul style="list-style-type: none"> • The OIL-Check 400 must only be transported or stored by authorised and trained, skilled personnel. • Observe the general safety and accident prevention regulations when transporting the OIL-Check 400. • Only use suitable and technically faultless lifting and hoisting tools with sufficient lifting capacity for transport. • The system must be handled with due care. • After opening the transport packaging , inspect the system for possible damage. • Never expose the device to continuous, direct sunlight or heat radiation.

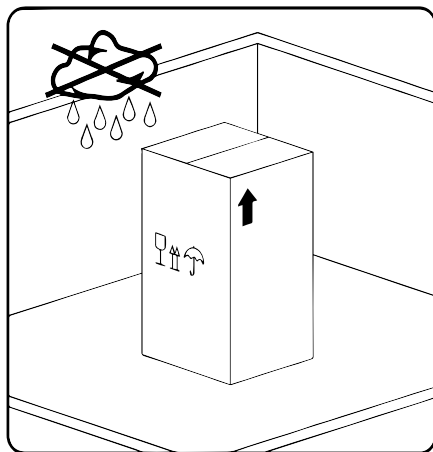

CAUTION	Use of protective clothing
	<p>To prevent injury to hands and feet when transporting the OIL-Check 400, personnel must wear suitable personal protective equipment and safety footwear!</p>

CAUTION	Danger caused by damaged components
	Never utilise any damaged components. Defective components could impair the operational safety or result in incorrect measurements and cause subsequent damage.



- The **OIL-Check 400** must be stored in the original packaging in a closed, dry as well as frost-free room.
- Ensure that the ambient conditions do not undershoot and/or exceed the details or information on the type plate.
- Always take suitable measures to protect the **OIL-Check 400** against the elements even in a packaged condition.
- Secure the **OIL-Check 400** against falling over and protect it against impacts and vibrations.





NOTE	Additional information
	Always retain the installation and operation manual together with the product. Please contact the manufacturer for storage times exceeding 6 months.

NOTE	Recycling packaging material
 	The packaging material is recyclable. Dispose of the packaging material according to the applicable statutory regulations.

3 Product information and device description

3.1 Type plate

The type plate is attached to the measuring device housing. It contains all relevant technical data about the **OIL-Check 400** measuring system. Please have these details to hand when contacting the manufacturer and/or supplier.

<p>German explanation</p> <p>Produktbezeichnung</p> <p>Baujahr</p> <p>Typ</p> <p>Serien-Nr.</p> <p>Versorgungsspannung</p> <p>Frequenzbereich</p> <p>Max. Leistungsaufnahme</p> <p>Max. Stromaufnahme</p> <p>Schutzart</p> <p>Umgebungstemperatur</p> <p>Gewicht</p> <p>Messgas-System</p> <p>Messgas Druckluft</p> <p>Betriebsdruck</p> <p>Betriebstemperatur</p>	<div style="display: flex; align-items: center;">  <div> <p>CS Instruments GmbH & Co. KG Am Oker 28c D-24955 Harrislee, GERMANY Tel: +49 461 807150-0 www.cs-instruments.com</p> </div> </div> <p>Product Name OIL-Check 400</p> <p>Year of Construction 05-2018</p> <p>Model: 4039709</p> <p>Serial No. 13676522</p> <p>Supply Voltage 100 ... 240 VAC/ 1Ph. / PE</p> <p>Frequency Range 50 ... 60 Hz</p> <p>Maximum Power Input 115 VA @ 230 VAC 104 VA @ 115 VAC</p> <p>Maximum Current Input 0.5 A @ 230 VAC 0.9 A @ 115 VAC</p> <p>Degree of Protection IP54</p> <p>Ambient Temperature +5 ... +45 °C</p> <p>Weight 16.3 kg</p> <p>Measuring gas system</p> <p>Measuring Gas Compressed Air</p> <p>Working Pressure 3 ... 16 bar(g)</p> <p>Operating temperature +5 ... +50 °C</p> <div style="display: flex; justify-content: space-around; align-items: center; margin-top: 10px;">    </div>
--	---

NOTE	Handling the rating plate
	Never damage, remove or make the type plate illegible. For more information on the symbols used, refer to "Pictograms and Symbols".

3.2 Product view



3.3 Functional description for OIL-Check 400

The purity of the compressed air with respect to the residual oil content is defined in the international standard **ISO 8573-1**. The **OIL-Check 400** has been developed for the detection of vapours and gaseous hydrocarbons in compressed air free from aggressive, corrosive, toxic and inflammable components. The sensor of the **OIL-Check 400** works with the tried and tested and reliable principle of photo-ionisation with a photo-ionisation detector (**PID Sensor**).

The measuring principle of a **PID** is based on the ionisation of the gas molecule via **UV radiation** and recording the thereby resulting ion flow. The normal integral parts of the compressed air (oxygen, nitrogen, carbon dioxide, argon, water, etc.) are not ionised by the UV lamp. Hydrocarbons, on the other hand, are reliably ionised. The strength of the ion current is directly proportional to the concentration of the ionised molecules. The electrical signal is measured, electronically amplified and displayed as the sum of the measured substances in the display.

The measuring gas (compressed air) is routed to the PID sensor directly or via the reference gas generation unit by the so-called **CATALYST**. In this way, the sensor will be cleaned at regular intervals and a new zero point is determined. The new zero point is then updated in the processor and acquired for the generation of measured values.

The reference gas generation is executed in a catalytic converter reactor.

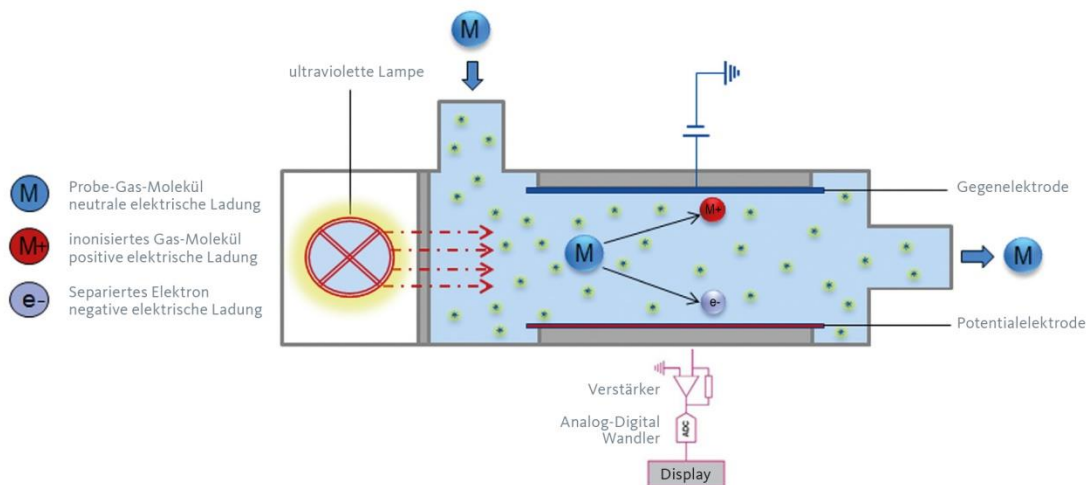

The PID sensor indicates the total concentration of all photo-ionisable compounds contained in the sample and does not distinguish between individual components / substances. Hydrocarbon compounds having less than 6 carbon atoms (<C₆) can also be detected, e.g. Isobutene. The prerequisite for this is however that these molecules are ionised by the UV lamp.

An integrated pressure regulator ensures a constant through flow in the pressure range of 3 ... 16 bar (ü). These measures ensure that the same operating conditions are always guaranteed for the PID sensor which, in turn, result in an increase in the measuring accuracy.

The measuring gas through flow and the operating pressure in the measuring chamber of the PID sensor correspond precisely to the calibration conditions. This measure also increases the measuring accuracy of the **OIL-Check 400**.

The function of the reference gas unit and of the PID sensor is permanently monitored for an appropriate operational safety and signalled by an LED. If a defined safety limit value is undershot and/or exceeded, then an alarm will be activated and the user will receive information to state that an inspection of the **OIL-Check 400** is necessary.

In the event of a malfunction, the LED switches from green to red. The measuring gas through flow to the PID sensor will be interrupted and the sensor is protected from excessive loads.

The modular design of the measuring device ensures fast execution of maintenance and service work.

The **OIL-Check 400** is a measuring device with very high measuring accuracy for the determination of the oil content in the compressed air. **To ensure extra precise measurements, all evaluated measuring values are compensated for temperature and**

pressure. This means that the compressed air temperature and the measuring chamber pressure will be measured and taken into account during the measurement value formation. **The device therefore fulfils the requirements of ISO 8573-5.**

The residual oil content will be displayed in **mg / Standard m³**.

The standard m³ relates to 1.0 bar absolute, +20°C, 0% relative humidity according to ISO 8573-1.

All accuracy data is based on the operating conditions as defined in the technical data.

3.3.1 Measurement value formation

In order to be able to process the signal voltage of the PID sensor in a processor, it must be initially digitalised. For this purpose, a circuit is implemented which is designated as an analogue - digital converter.

An updated measured value is available every 4 seconds. This measured value is a sliding average value from the last respective 80 seconds.

As is usual with displays with an analogue input, the input signal is initially filtered and then additionally processed. As a result of this filtering, the displayed measured value will not change abruptly, rather it will approach the current one as slightly delayed. This behaviour is systematic and therefore meaningful.

By means of this advantageous calculation method, undesired individual external influences which can be caused, for example, by malfunctions and interruptions in the electric grid or in the compressed air system are effectively suppressed.

3.4 Operating and display elements

3.4.1 LED-Display

The current measured value for the residual oil content in mg / Standard m³ is shown in the 3.5" graphic display with touch screen. The standard m³ relates to 1.0 bar absolute, +20°C, 0% relative humidity according to ISO 8573-1.



3.4.2 Operating messages

The operating statuses of the individual components are permanently monitored and signalled by means of LEDs. A potential-free changeover contact provides the possibility of forwarding the operating messages.

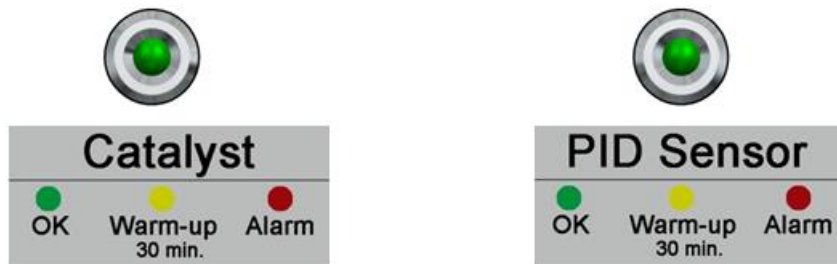

<p>Catalyst</p> <p>OK Warm-up 30 min. Alarm</p>	<p>Operating message CATALYST</p> <ul style="list-style-type: none"> • A green LED indicates the trouble-free operation of the catalytic converter unit for the generation of zero-air, the so-called CATALYST. • In the event of a malfunction of the CATALYST, the LED switches from GREEN to RED.
<p>PID Sensor</p> <p>OK Warm-up 30 min. Alarm</p>	<p>Operating message PID sensor</p> <ul style="list-style-type: none"> • A green LED indicates the interference-free operation of the PID sensor. • In case of a PID sensor operational malfunction, the LED switches from GREEN to RED.
<p>If a deviation from the defined parameters is detected in the monitoring software, then the programme switches over to safe operation and switches off the compressed air supply to the PID sensor. The alarm status will be signalled by the red LED of the corresponding LED and a potential-free changeover contact switches.</p>	

3.5 Parts and components

The **OIL-Check 400** measuring device for recording vapours and gaseous hydrocarbons in the compressed air comprises the following components:

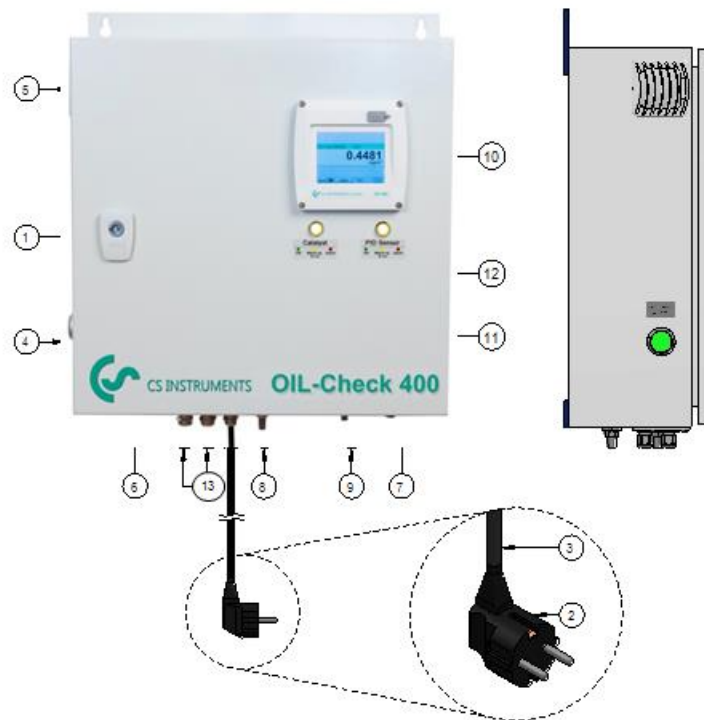

- 1 Wall housing made of steel sheet. Powder coating inside and outside, RAL 7035
- 2 Mains plug with protective contact
- 3 Electrical connection cable, 2.5 m long
- 4 Power switch for electrical power supply
- 5 Ventilation exhaust filters
- 6 Device ventilator with filter
- 7 Connection for the measuring gas: Pneumatic INLET
- 8 Muffler No. 1 for the zero air OUTLET
- 9 Muffler No. 2 for the compressed air OUTLET
- 10 Measured value display
- 11 LED-1 / operating message CATALYST
- 12 LED-2 / operating message PID sensor
- 13 Cable glands for customer electrical connections, 6 pieces M12x1.5

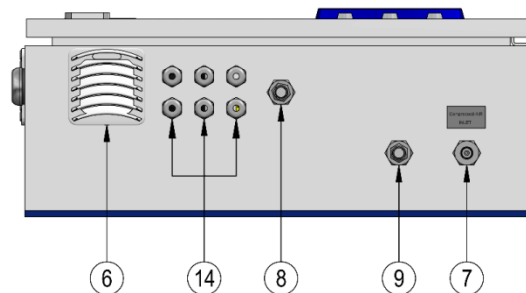
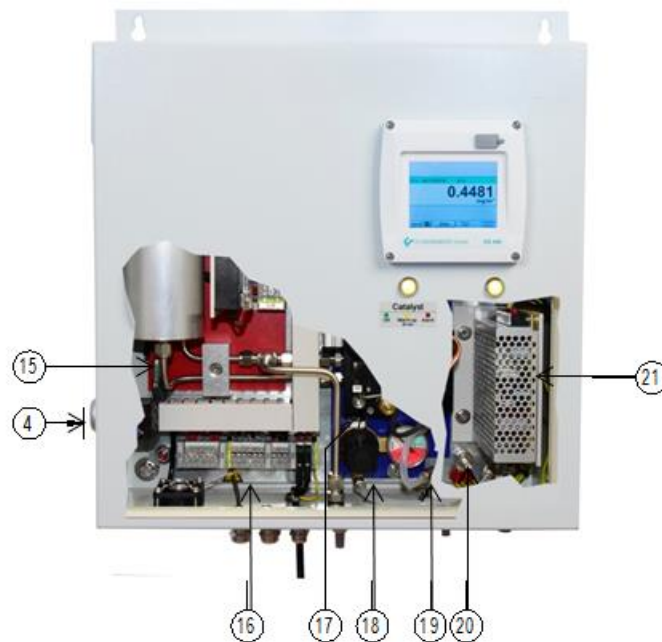

- 15 CATALYST, catalytic converter unit for generating zero-air
- 16 Screw terminals for electrical connections
- 17 Safety valve for the measuring gas components
- 18 Oil and grease-free pressure regulator
- 19 Pressure gauge for measuring gas operating pressure
- 20 Sensor module including solenoid valves, pressure switch, PID sensor and pressure regulator
- 21 Switching power supply for the voltage supply, 100-240VAC / 50-60Hz / $\pm 10\%$

3.6 Pressure reducer for compressed air inlet

There is a pressure reducer, Position 18, for the compressed air located inside the housing of the **OIL-Check 400**. This pressure reducer is used to regulate the pressure of the measurement gas and is set at an operating pressure of approx. 2.5 bar (ü) as default.

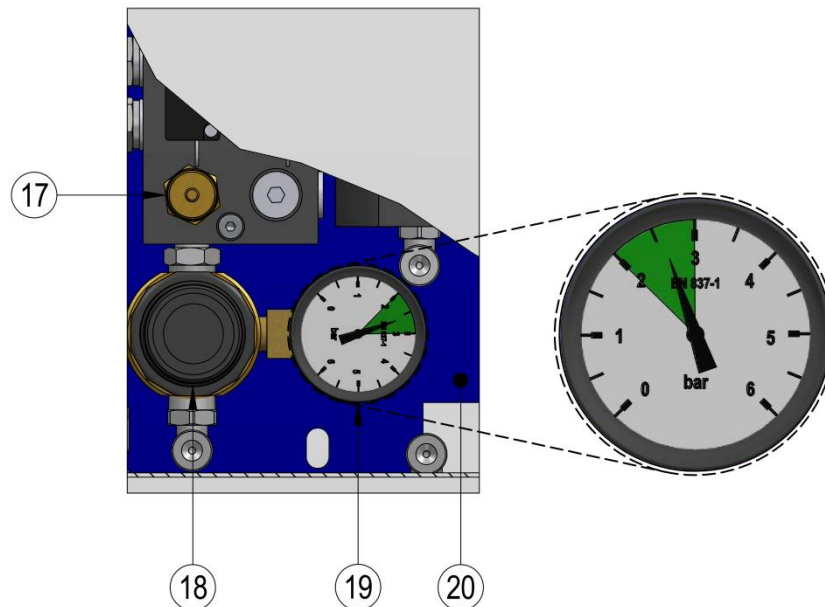

If it is necessary to change the setting of the pressure regulator, proceed as follows:

- Unlock the pressure regulator's adjustment head by pulling the hand wheel upwards.
- Release the line pressure by turning the hand wheel (18) anti-clockwise.
- Turning the hand wheel clockwise produces an increase in the initial pressure. Turning the hand wheel anti-clockwise generates a reduction in the output pressure.
- Control the pressure on the manometer of the pressure regulator.
- Lock the adjustment head of the pressure regulator by pressing the hand wheel downwards.

3.7 Dimensions

All dimensions in mm

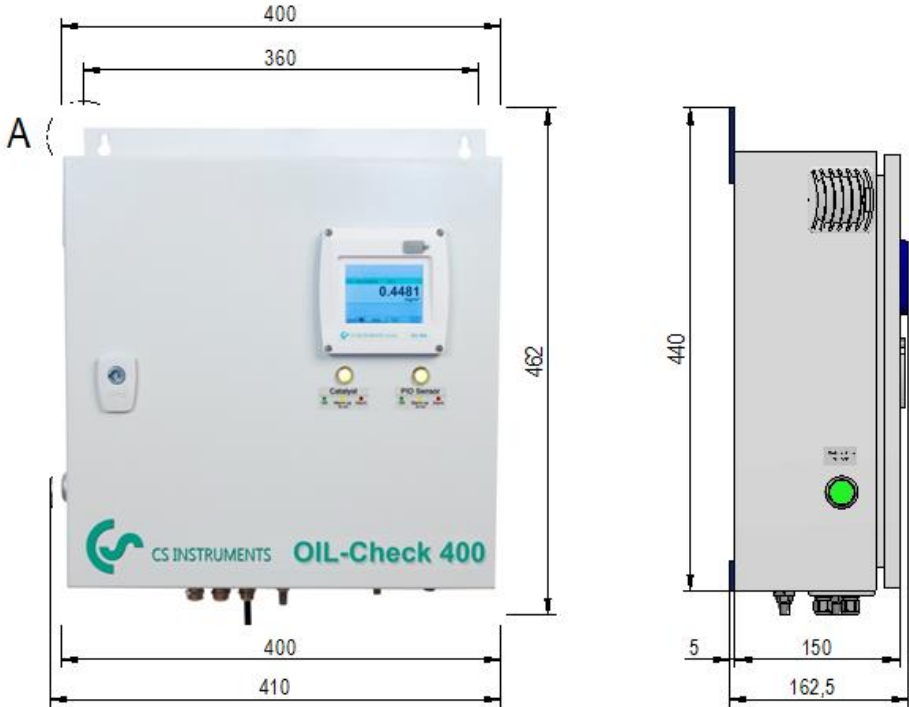

3.8 Technical data OIL-Check 400

Technical data OIL-Check 400® with LED display							
Measuring medium	Compressed air, free of aggressive, corrosive, caustic, toxic, flammable or oxidising integral parts. Fluid group 2 according to pressure device directive 2014/68/EU. The use of a compressed air preparation adapted to the measurement task is necessary.						
Measured parameter	Residual oil content in mg of oil/normal m ³ , relative to 1.0 bar, +20°C, 0% relative humidity, according to ISO 8573-1						
Detectable substances	Polyalphaolefines, aromatics, hydrocarbons, aliphatic hydrocarbons and functional hydrocarbons						
Application areas	Downstream of activated carbon filter or activated carbon adsorber Downstream of oil-free compressor Always combined with upstream filtration and drying						
ambient temperature	+5°C to +45°C, relative humidity ≤ 75%, non-condensing						
Storage temperature	+5°C to +50°C						
Ambient pressure	800...1200 mbar absolute						
Climatic resistance	Relative humidity ≤ 75% in annual average without condensation						
Compressed air temperature	+5°C to +50°C						
Excess operating pressure	3 ... 16 bar (gauge)						
Measuring gas humidity	≤ 40 % relative humidity, DTP maximum +10°C Non-condensing humidity						
Compressed air connection	G 1/8" female thread according to ISO 228-1						
Measurement values	mg / standard m ³ , pressure and temperature compensated						
Measuring range	≤ 0.01 ... 2.50 mg/m ³						
Calibrated measuring range	≤ 0.01...1.25 mg/m ³ residual oil content, according to ISO 8573-1!						
Detection limit (residual oil)	0.001 mg/m ³						
Determination limit (residual oil)	0.003 mg/m ³						
Measuring range and accuracy	<table style="width: 100%; border: none;"> <tr> <td style="width: 60%;">$\leq 0.01 \dots 0.5 \text{ mg/m}^3$</td> <td style="width: 40%;">$\pm 30\%$ from average ± 0.001</td> </tr> <tr> <td>$\geq 0.5 \dots 1.0 \text{ mg/m}^3$</td> <td>$\pm 20\%$ from average ± 0.001</td> </tr> <tr> <td>$\geq 1.0 \dots 2.5 \text{ mg/m}^3$</td> <td>$\pm 10\%$ from average ± 0.001</td> </tr> </table>	$\leq 0.01 \dots 0.5 \text{ mg/m}^3$	$\pm 30\%$ from average ± 0.001	$\geq 0.5 \dots 1.0 \text{ mg/m}^3$	$\pm 20\%$ from average ± 0.001	$\geq 1.0 \dots 2.5 \text{ mg/m}^3$	$\pm 10\%$ from average ± 0.001
$\leq 0.01 \dots 0.5 \text{ mg/m}^3$	$\pm 30\%$ from average ± 0.001						
$\geq 0.5 \dots 1.0 \text{ mg/m}^3$	$\pm 20\%$ from average ± 0.001						
$\geq 1.0 \dots 2.5 \text{ mg/m}^3$	$\pm 10\%$ from average ± 0.001						

Technical data OIL-Check 400® with LED display	
Measuring gas through flow rate	Approx. 1.20 Standard litre / minute relative to 1.0 bar absolute and +20°C, depressurised status
Power supply	100-240 VAC / 1Ph. / PE / 50-60 Hz / ± 10%
Maximum operating current	0.50 A at 230 VAC / 0.90 A at 115 VAC
Power consumption	115 VA at 230 VAC / 104 VA at 115 VAC
Internal backup	2.5 AT (inertia)
Power cable	Maximum diameter: 6.5 mm, strand cross-section: 0.75 mm ² , with protective contact plug and PE protection
Protection class	IP54 / DIN EN 60529
Outputs	4 ... 20 mA active analogue output, 2-wire system, RS-485, MODBUS RTU for the transmission of measured values 1 alarm contact, normally open contact
Dimensions	410 x 462 x 162.5 mm (W x H x D)
Weight	Approx. 16.3 kg

NOTE	Additional information
	<ul style="list-style-type: none"> • The measuring gas will be released to the ambient air. Observe the resulting concentrations at the installation location of the OIL-Check 400. Ensure adequate ventilation. • Nachweisgrenze / Limit Of Detection, LOD Extreme value of measuring method, up to which the measured value can still be reliably detected. It is therefore a qualitative (yes/no) limit. • Bestimmungsgrenze / Limit Of Quantification, LOQ The smallest concentration of an analyte, which can be determined quantitatively with the specified accuracy. Quantitative results with the specified accuracy will only be initially indicated above the limit of quantification.

3.9 Applied EU Directives and harmonised standards

The device fulfils the essential requirements of the following directives and harmonised standards:

2014/68/EU Pressure Equipment Directive

2014/35/EU Low Voltage Directive

2014/30/EU Guideline relating to electromagnetic compatibility, EMC directive

EN 61010-1 Safety requirements for electrical measuring, control, regulating and laboratory equipment

EN 61326-1 Electrical equipment for measurement, control, regulating and laboratory use
EMC requirements

4 Assembly

4.1 Safety instructions

NOTE	Skilled technical personnel
	<ul style="list-style-type: none"> • Installation and assembly works may only be executed by qualified, skilled personnel after thoroughly studying the the original operating instructions. • It is the responsibility of the product operator to ensure that the instructions in this manual are adhered to. The qualification and knowledge of skilled technical personnel must be assessed according to the applicable regulations and standards. • To ensure safe operation, the system must be installed and operated according to the instructions in this operating manual. In addition to these instructions, always comply with the required statutory regulations for the application cases for system operation and company safety regulations as well as accident prevention regulations. This also applies analogously to the use of accessories and spare parts.

DANGER!	Compressed air! Gases under high pressure
	<ul style="list-style-type: none"> • Never work on any of the compressed air systems when they are pressurised. • The owner and/or operator must ensure that the system is never operated at a pressure higher than the maximum pressure value indicated on the rating plate. • Exceeding the maximum operating pressure can be dangerous for the operator as well as for the system.

CAUTION	Compressed air quality
	<ul style="list-style-type: none"> • The compressed air must be free of aggressive, corrosive, caustic, toxic, flammable or oxidising substances. • The compressed air must be supplied free of dust and water. • The maximum relative humidity of the compressed air must be less than 40 % (maximum pressure dew point of + 10 ° Ctd). • The use of a compressed air preparation adapted to the measurement task is necessary.

DANGER!	Electric power
	<p>Touchable conductive parts can lead to dangerous voltages / mains voltage during installation and maintenance or in case of defects. Hazard resulting in of serious or even fatal injury from electric shock when coming into contact with uninsulated parts or mains voltage.</p> <ul style="list-style-type: none"> • All works on the electrical parts of the measuring system may only be executed by appropriately trained skilled personnel. • The measuring device must not be operated when the power supply cables indicate damage or the housing parts have been damaged or removed. • The local valid legal regulations and provisions must be complied with without exception. • Observe the electrical data provided on the rating plate. • Work on the electrical connections may only be executed when the power supply is switched off. The device must be protected against unintentional reconnection or switching on again. • Only utilise components for the electrical installation which have a current approval and are labelled with a CE-Identification Marking. • The wire ends to be connected to the control unit must be equipped with wire-end ferrules. • All electrical connections must be inspected before commissioning and at regular intervals.

WARNING!	Operation of plant outside limit range
	<p>If the specified limiting values are undershot and/or exceeded, then there will be a danger for people or materials and device malfunctions and operation malfunctions could occur as well as incorrect measuring results.</p> <ul style="list-style-type: none">• The OIL-Check 400 measuring device may only be used in accordance with its intended use and within the permitted limiting values stated on the rating plate as well as in the technical data.• Always adhere to the permitted storage and transport conditions.

4.2 Fundamental requirements for the installation

NOTE	Execute a temperature compensation
	<p>High ambient temperature fluctuations during transport, storage or installation, can cause damage to the device or impair its measuring accuracy.</p> <ul style="list-style-type: none"> • Ensure that the OIL-Check 400 has been unpacked and stored at the installation site approx. 3 hours before the installation and temperature compensation with the environment has been possible. During the acclimatisation time, do not connect the measuring device to the electric power supply. • The catalytic converter unit CATALYST for the reference gas generation system requires a pre-heating time of approx. 0.5 hours. No compressed air must flow through the OIL-Check 400 until this time period has expired. • This process is particularly important where there are significant temperature difference between the transport/storage location and the operating environment.

- Installation in inappropriate ambient conditions will affect the results of the measurement and can result in malfunctions and damage to the measuring device.
- The installation location of the **OIL-Check 400** measurement system must be easily accessible.
- Always select a clean and dry zone, free of dust, which is protected against atmospheric disturbances.
- Protect the measuring device against direct sunlight.
- Never install the **OIL-Check 400** in an environment where corrosive chemicals, explosive gases, toxic gases, high ambient temperatures, heat from evaporation or extreme soiling, dirt or dust are present.
- The load bearing area must be smooth and capable of supporting the weight of the measuring device.
- No vibrations, oscillations or pulsations may be transmitted to the measuring device.
- Overheating will damage the electronic components.
- Minimum ambient temperature +5 °C
- Maximum ambient temperature + 45 °C
- Always ensure unimpeded air exchange and sufficient ventilation.

NOTE	Quality of connecting components
	The connecting pipework, fittings and shaped pieces must be free of dust, rust, oil, grease and other contamination or impurities.

Please note:

- Only ever use fittings and connecting elements which are approved for this application.
- Only ever use pipework, valves and fittings which are suitable for the pressure and temperature range. Always adhere to the manufacturer's instructions.
- Pay attention to the correct installation of the connections.
- After installation, inspect all pipe and cable connections and tighten them when necessary!
- Prior to commissioning, a leak test must be executed by appropriately qualified, skilled personnel and observing the safety regulations.

The **OIL-Check 400** has been developed for the detection of vapours and gaseous hydrocarbons in compressed air free from aggressive, corrosive, toxic and inflammable components.

The measuring gas must be supplied to the measuring device free of dust and water. The utilisation of a compressed air treatment plant adjusted to the measurement task is therefore necessary in most application cases.

In the following, installation examples for the compressed air treatment will be represented to illustrate how the **OIL-Check 400** measuring device can be operated without any problems.

4.3 Wall mounting

The device must be assembled vertical on the wall using suitable wall plugs and screws. Refer to the following drawings for details.

NOTE	Quality of connecting components
	Always use fixtures that can carry at least 4 times the weight of the device (70 kg) for wall mounting.

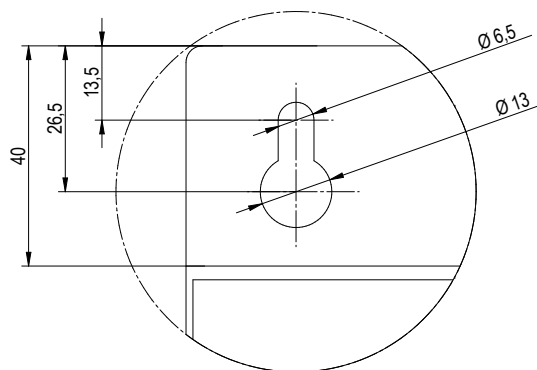
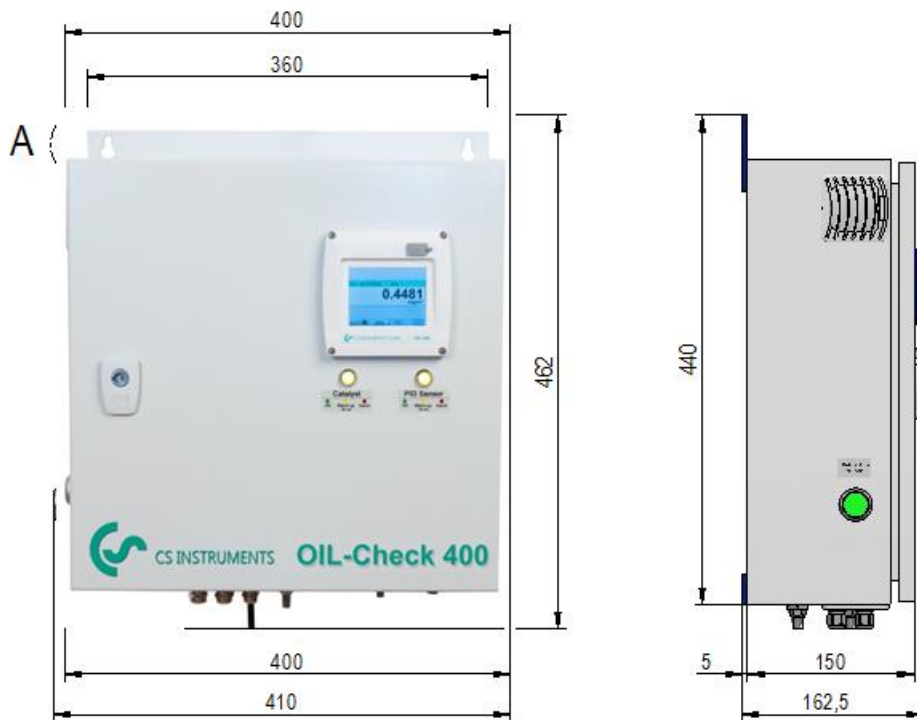

Detail A

4.4 Device connections

All the connections necessary for operation are located on the underside of the housing.

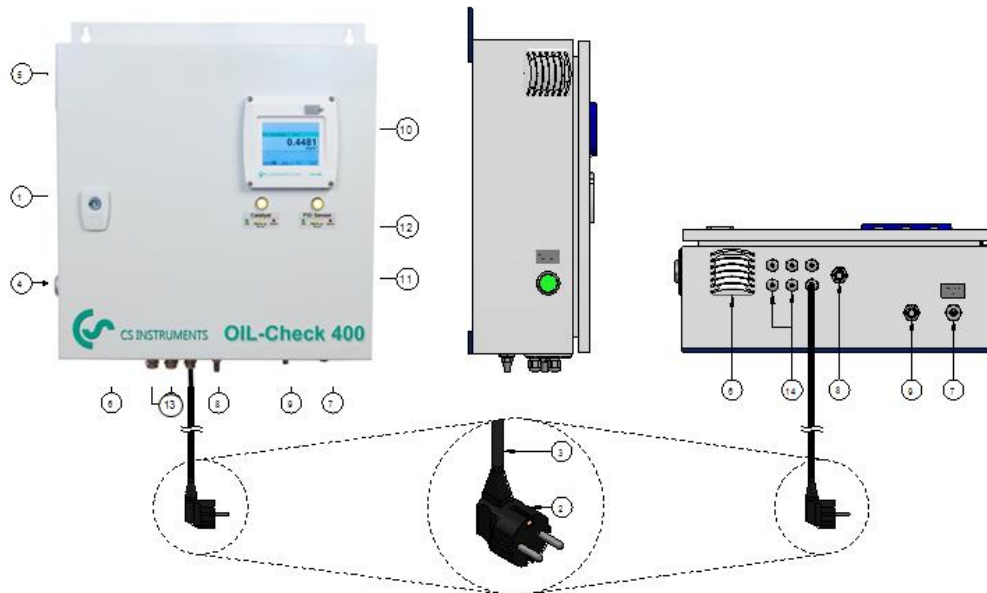

- 2 Mains plug with protective contact
- 3 Electrical connection cable, 2.5 m long
- 4 Power switch for electrical power supply
- 6 Device ventilator with filter
- 7 **Compressed air INLET, female thread G1/8" / ISO 228-1**
- 8 Muffler No. 1 for the zero air OUTLET
- 9 Muffler No. 2 for the compressed air OUTLET
- 13 Cable glands for customer electrical connections, 6 pieces M12x1.5

4.5 Assembly of compressed air connection

The process connection for compressed air **Position 7** is located on the underside of the housing.

The connection is designed as a **cylindrical internal thread G1/8” according to ISO 228-1**.

This connection is used to connect the measuring device to the compressed air system.

The pipe connections must be sealed with appropriate sealing rings.

4.5.1 Sampling

The sampling type and method is also of particular importance to ensure an accurate oil content measurement. The sample should be taken at a point where it can be ensured that a **representative and usable mixture** of all components of the compressed air is present.

In the case of gaseous and vaporous organic substances, it can be assumed that they are distributed homogeneously over the measurement cross-section. In the case of a homogeneous distribution, the gases can be removed at a fixed point approximately at the centre of the measuring cross-section.

The following sampling options are available:

- **Mobile sampling system consisting of 2 m PTFE hose, quick lock coupling (oil- and grease free)**
- **Sampling system consisting of ½" ball valve (oil- and grease-free), 1 m stainless steel pipe 6 x 1 mm (oil- and grease-free), clamp screwing (oil- and grease-free)**

4.5.2 Connection to the compressed air system

After you have selected the appropriate type of sampling, proceed as follows to connect the measuring device to the compressed air network:

1. Connect the measuring device correctly to the compressed air line.
2. Inspect compliance with the safety instructions for the ambient conditions.
Refer to the chapter for "Assembly"
3. Inspect compliance with the safety instructions relating to the **quality of the compressed air**.
Refer to the chapter for "Assembly"
4. Inspect compliance with the safety instructions relating to the **quality of the connection components**. Refer to the chapter for "Assembly"
5. The following connection is recommended between the shut-off ball valve **Position H1** and the **compressed air INLET Position 7** of the measuring device:

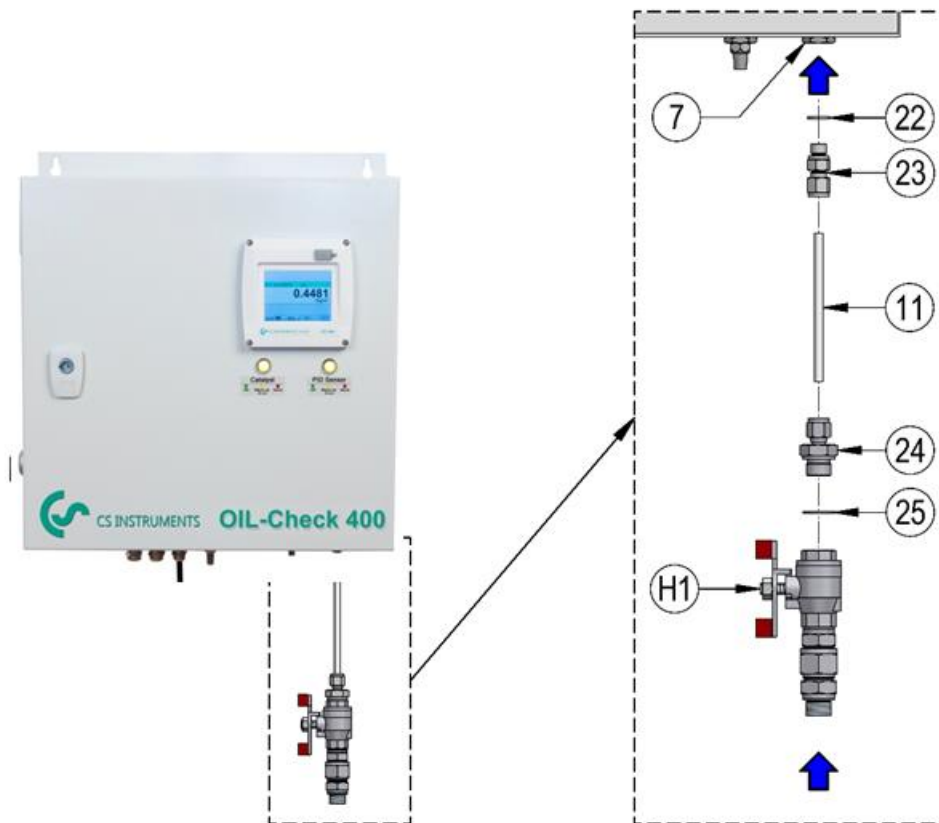

The following oil-free and fat-free connection components will be utilised



- Position 11 Seamless stainless steel pipe, **Ø 6 x 1.0 mm**, Material No. 1.4571, delivery conditions according to EN 10216-5, **oil-free and grease-free design**

- Position 22 Sealing ring for ISO parallel thread, **G1/8"**, stainless steel sealing ring with VITON (FKM) model KPC-C-01-316VD, manufactured by Hy-Lok

- Position 23 Clamping ring bolt, metric pipe on ISO parallel thread (G-thread, ISO 228-1) **G1/8" external thread x Ø 6 mm**, model CMC6M-2G Manufacturer Hy-Lok

- Position 24 Clamping ring bolt, metric pipe on ISO parallel thread (G-thread, ISO 228-1) **G3/8" external thread x Ø 6 mm**, model CMC6M-6G Manufacturer Hy-Lok

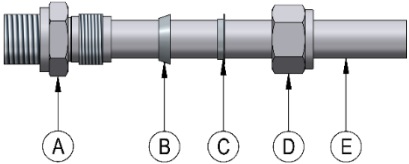
- Position 25 Sealing ring for ISO parallel thread, **G3/8"**, stainless steel sealing ring with VITON (FKM) model KPC-C-03-316VD, manufactured by Hy-Lok

Structure of a clamping ring bolt connection	
	
<p>Position A Bolt body</p> <p>Position B Front clamping ring</p> <p>Position C Rear clamping ring</p>	<p>Position D Locking nut</p> <p>Position E Seamless stainless steel pipe</p>
<p>During assembly, the rotational movement of the nut is converted by the rear clamping ring into an axial movement along the pipe. The sealing on the front clamping ring is executed by the axial pressing and non-rotation. As a result, neither depths nor tensions are created on the pipe.</p>	
<p>Note</p> <ul style="list-style-type: none"> Never force the pipe into the clamping rings. If the pipe cannot be pushed easily into the bolted connection, then it could be that it has not been deburred or it is oval. Use a sharp pipe cutter and do not exert too much pressure on the cutting wheel. This prevents deformations at the end of the pipe. 	

Assembly instructions for Hy-Lok compression fittings

Initial assembly

To avoid confusion or contamination during disassembly, Hy-Lok bolted connections are delivered ready for installation and finger-tightened. The pipe must be cut at right angles and deburred.

Step 1

Push the pipe carefully and gently into the bolted connection as far as it will go.

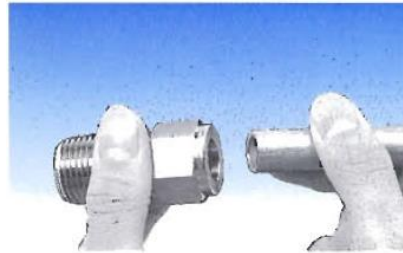

Step 2

Ensure that the nut is hand-tightened. Mark the 6 o'clock position as the starting point for the assembly. Then tighten the nut **1 1/4 turns**. Hold the fitting body with a second wrench.

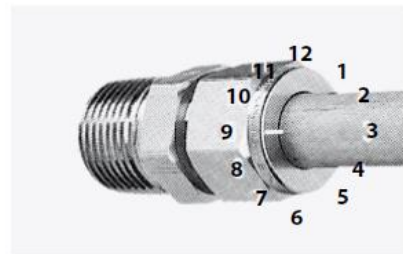

Reassembly

The bolted connections can be loosened several times and reassembled. Ensure that the sealing surfaces are clean and positioned on the surface without damage.

1. Slide the pipe with the clamping rings up to the end stop in the fitting body.
2. Turn the nut finger-tight and then tighten it with a wrench until you feel a strong increase in the force which needs to be exerted, about **1/4 turn!** Hold the fitting body tightly with a second wrench. The tight manufacturing tolerances will cause the marking to be in the same position as after the initial assembly.

6. Inspect all bolt fittings for correct seating and tightness.
7. Subsequently initiate a leak tightness examination for the whole installation.

4.6 Electrical installation

4.6.1 Safety instructions

DANGER!	Electric power
	<p>Touchable conductive parts can lead to dangerous voltages / mains voltage during installation and maintenance or in case of defects. Hazard resulting in of serious or even fatal injury from electric shock when coming into contact with uninsulated parts or mains voltage.</p> <ul style="list-style-type: none"> • All works on the electrical parts of the measuring system may only be executed by appropriately trained skilled personnel. • The measuring device must not be operated when the power supply cables indicate damage or the housing parts have been damaged or removed. • The local valid legal regulations and provisions must be complied with without exception. • Observe the electrical data provided on the rating plate. • Work on the electrical connections may only be executed when the power supply is switched off. The device must be protected against unintentional reconnection or switching on again. • Only utilise components for the electrical installation which have a current approval and are labelled with a CE-Identification Marking. • The wire ends to be connected to the control unit must be equipped with wire-end ferrules. • All electrical connections must be inspected before commissioning and at regular intervals.

DANGER!	Operation without earth connection
	<p>If there is a fault but no earth connection (protective earth), conductive components might become energized, posing a risk of serious or even fatal injury.</p> <p>The device is earthed via the mains cable.</p> <ul style="list-style-type: none"> • The system must always therefore be earthed and/or connected to a protective earth conductor. • The device may only be connected to an earthed socket. • Do not use plug adapters at the power plug. If required, have the power plug replaced by a qualified electrician. • Only use the supplied mains cable for connecting the system. • Only replace a damaged mains power cable with an equivalent cable.

DANGER!	Operation without circuit breaker
	<p>All components that are dangerous when touched due to their voltage must be disconnectable by means of dedicated external circuit breakers.</p> <ul style="list-style-type: none"> • The circuit breaker must be installed in the vicinity of the device. • The circuit breaker must conform to IEC 60947-1 and IEC 60947-3. • The circuit breaker must disconnect all electrical conductors from the mains power supply. • The circuit breaker must not be installed in the power supply line. • The circuit breaker must at all times be easily accessible to operating personnel.

DANGER!	Power supply - External power circuits
	<p>When wiring the electric power supply line, ensure that the double or reinforced insulation between the electric circuits and the secondary circuit remains intact.</p> <ul style="list-style-type: none">• The additional insulation must be suitable for a test voltage of 1500 VAC.• The thickness of the insulation must be at least 0.4 mm, e.g. insulating sleeve, model BIS 85 (Bierther GmbH).

DANGER!	Damaged power cable
	<ul style="list-style-type: none">• Only use the supplied mains cable for connecting the system.• Only replace a damaged mains power cable with an equivalent cable. The specification for the mains supply can be found in Chapter 7.6

4.6.2 Power supply and fuses

The measuring device is supplied with a mains cable and is intended for connection to a protective earthed mains socket. The device is equipped with a wide-range voltage input and can be operated from 100 ... 240 VAC mains voltage at 50 ... 60 Hz mains frequency. The socket must be fused with a 2 to 16 A line circuit breaker.

The measuring device is equipped with a two-pin ON / OFF switch for the electrical voltage supply.

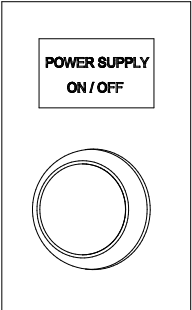
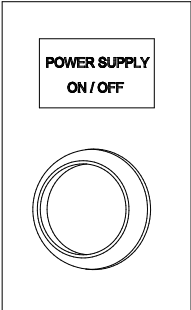
Position 4 ON / OFF switch with luminaire		
		<p>The ON / OFF switch is designed as an illuminated push button with a latching function. If the button is located in the lower position - ON position - (lowered button), then the voltage supply is present on the device. A green light indicates the operating condition.</p>

Furthermore, the device is fused on the primary side with two fuses of **2.5 A load**. These are located in the fuse holders of terminals **X24: L** and **X24: N** and are marked with **F2** and **F3**.

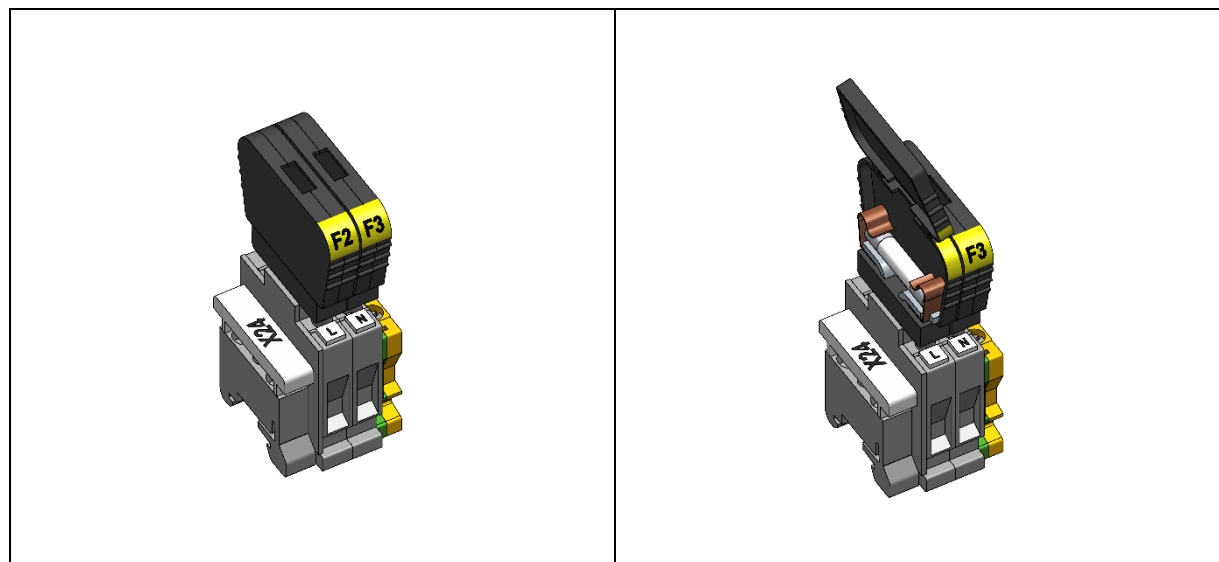

4.6.3 Terminals for electrical connections

CAUTION	Electrostatic Discharge (ESD)
	The housing must be opened to install the analogue and digital outputs. Electrostatic discharges can damage the unit. Follow the instructions for ESD protection in Chapter "7.1.1" Preventing electrostatic discharge (ESD) ".

NOTE	Execute a temperature compensation
	<p>High ambient temperature fluctuations during transport, storage or installation, can cause damage to the device or impair its measuring accuracy.</p> <ul style="list-style-type: none"> • Ensure that the OIL-Check 400 has been unpacked and stored at the installation site for approx. 3 hours before the installation and temperature compensation with the environment has been possible. During the acclimatisation time, do not connect the measuring device to the electric power supply. • The catalytic converter unit CATALYST for the reference gas generation system requires a pre-heating time of approx. 0.5 hours. No compressed air must flow through the OIL-Check 400 until this time period has expired. • This process is particularly important where there are significant temperature difference between the transport/storage location and the operating environment.



- Position 4 Power switch for electrical power supply
- Position 16 Screw terminals for electrical connections

All electrical connections are screw terminals. The maximum cross section for electrical cables is **2.5 mm²**.

Open the device, insert the cables through the screw connections into the device and connect the cables according to the following terminal assignment. Then firmly tighten the cable glands. Close unused feed-throughs with a blind plug. Close the unit again.

Do not connect the mains plug until the temperature has been adjusted.

For the electrical installation, refer to the table and wiring diagrams below.

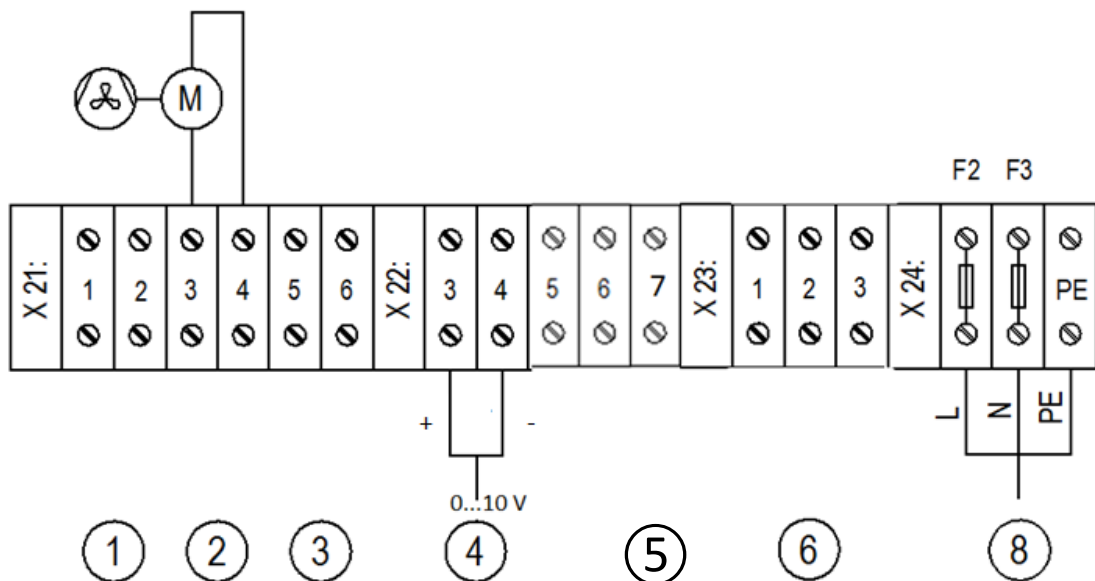

Position	Connection designation	Terminal block / terminals
1	Power supply 24 VDC , for internal connections	X21: 1 2
2	Power supply 24 VDC , for the internal device fan	X21: 3 4
3	Power supply 24 VDC , for the internal connections	X21: 5 6
4	Analogue output 0...10 V for measured value transmission, 0 ... 2.5 mg oil/m³	X22: 3 4
5	For internal use	X22: 5 6 7
6	For internal use	X23: 1 2 3
8	Voltage supply 100-240 VAC / 1Ph. / 50-60 Hz / PE / ± 10%	X24: L N PE

1) General information about the contact load of relays

Every electrical consumer represents a mixed load with ohmic, capacitive and inductive shares. When switching these loads, a more or less large load will be produced for the switching contact. This load can be reduced by a suitable contact protection circuit. Since in practice mainly consumers with large inductive

shares such as contactors, solenoid valves, motors, etc. are implemented, then these applications should be considered in more detail.

Due to the energy stored in the coil, voltage peaks with values up to several thousand volts will be generated when switching off. These high voltages cause an arc on the switching contact which can destroy the contact by material evaporation and material migration. The electrical service life is thereby considerably reduced.

In an extreme case, the relay can fail during the first switching operation when the voltage is constant and the arc is at a standstill. To suppress the formation of the arc, a protective circuit must be used. With optimised dimensioning, nearly all the same switching cycles can be achieved as with ohmic load.

In principle there are various possibilities for providing effective wiring:

- Switching executed on the contact,
- switching executed on the consumer,
- combination of both circuits.

In principle, a protective measure should be implemented directly where the source of the malfunction occurs. The switching circuitry of the consumer must therefore be assumed as the switching circuitry of the contact.

4.6.4 Connection terminals for the potential-free contacts

The designs in this chapter refer to the electrical cable connections (connection No. 6 and No. 7). Observe all instructions before connecting the device. It will otherwise be damaged.

DANGER!	Missing connection with the protective conductor
	<p>The connection to the protective conductor must be ensured before an electrical connection is established with the circuit of the potential-free contact.</p> <p>Before pulling the mains plug, the voltage-free contact of the potential-free contact must be established.</p>

DANGER!	Mains voltage
	<p>When wiring the electric power supply line, it must be ensured that the doubled up or reinforced insulation between the electric circuits which are hazardous when touched and secondary circuits which can be touched always remains intact.</p>

When the insulation of the connecting cables is not designed for the nominal voltage $U_0/U = 300/500$ VAC and is not designed for the test voltage of at least 1500 VAC, then the conductors must be provided with additional insulation.

NOTE	Additional insulation
	<p>The additional insulation must be suitable for a test voltage of 1500 VAC. The thickness of the insulation must be at least 0.4 mm. e.g. insulation hose, model Typ BIS 85 (Bierther GmbH).</p>

The terminal bar X23: (Position 36) with the terminals No. 1,2,3,4,5 is used exclusively for the connection of the potential-free contacts.

The potential-free changeover contact with the connection terminals X23: 1, X23: 2, X23: 3 for transmitting the operating messages and alarms of the CATALYST unit and the PID sensor, switches when a malfunction is present.

The potential-free normally open contact with the connection terminals X23: 4 and X23: 5 for the transmission of the limit value alarm for the residual oil content will switch when the set limit value is exceeded.

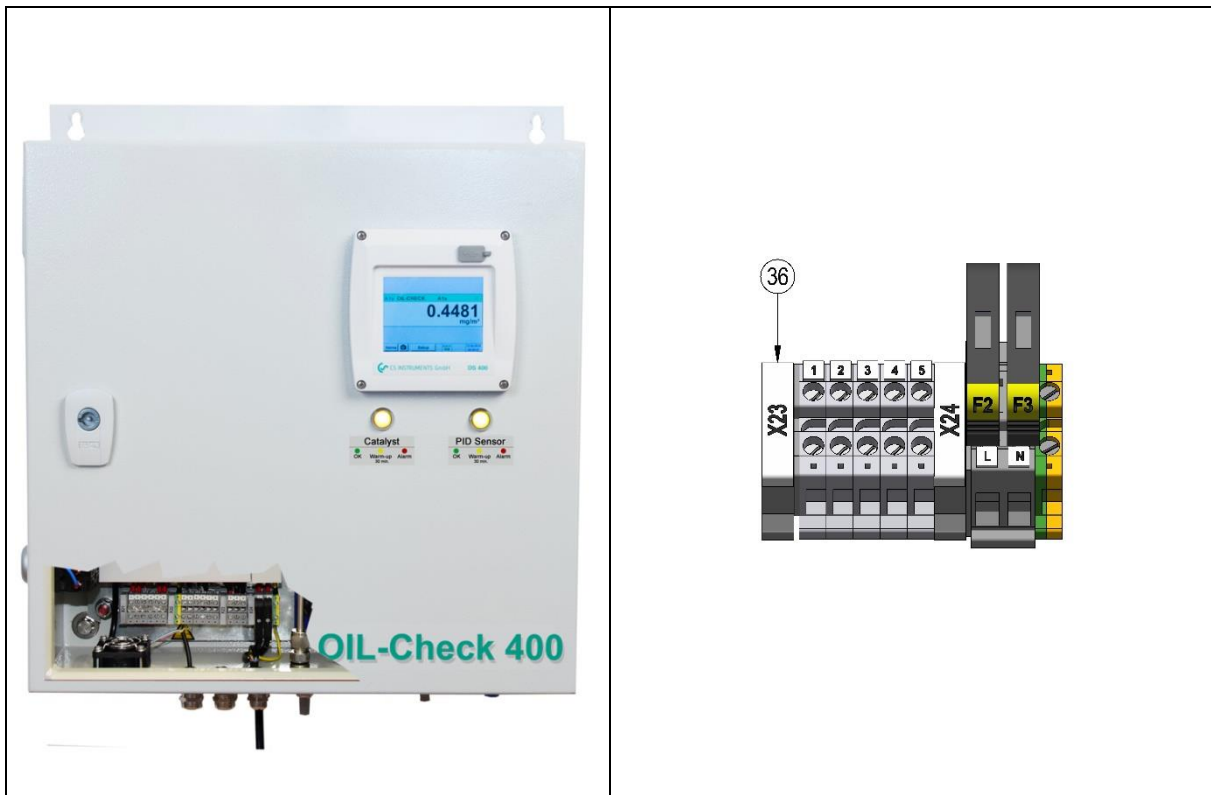

The additional insulation of the connection cables Position 37 for the potential-free contact can be implemented as follows:

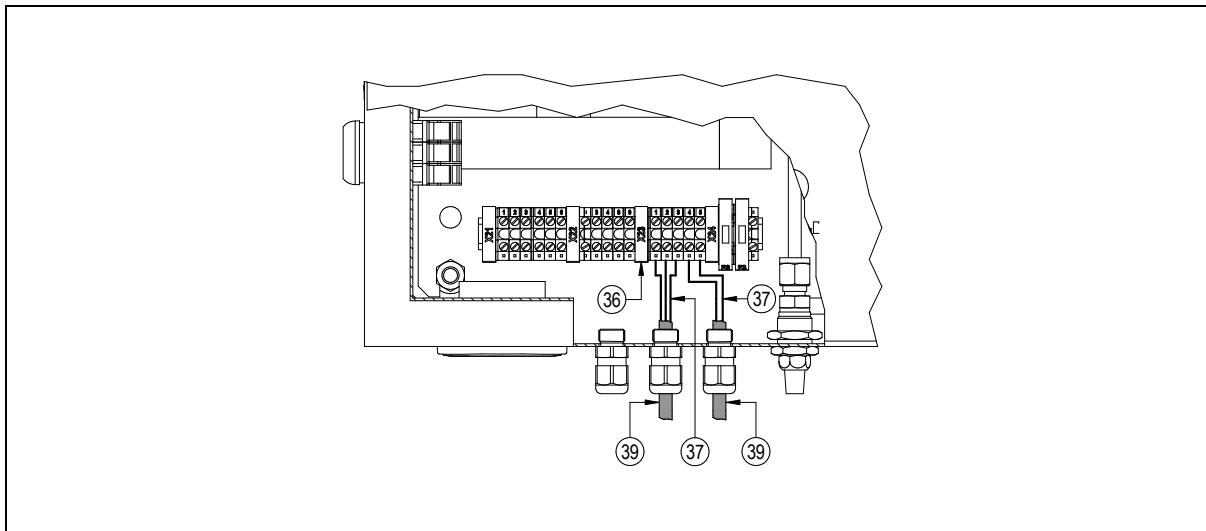

<p>Potential-free changeover contact for forwarding the operating messages and alarms of the CATALYST unit and the PID sensor.</p>	<p>Potential-free normally open contact for transferring the limit value alarm for the residual oil content.</p>
<p>Connection terminals X23: 1, X23: 2, X23: 3</p>	<p>Connection terminals X23: 4, X23: 5</p>

- Position 36 Connection terminals X23: 1, X23: 2, X23: 3 and X23: 4, X23: 5
- Position 37 Electrical conductor
- Position 38 Additional insulation for electrical conductors
- Position 39 Connection cable

5 Commissioning

CAUTION	Risks due to damaged components
	<p>Defective components can impair the functional safety, result in incorrect measurements and cause subsequent damage.</p> <ul style="list-style-type: none"> • <u>Never</u> operate with damaged components.

NOTE	Execute a temperature compensation
	<p>High ambient temperature fluctuations during transport, storage or installation, can cause damage to the device or impair its measuring accuracy.</p> <ul style="list-style-type: none"> • Ensure that the OIL-Check 400 has been unpacked and stored at the installation site for approx. 3 hours before the installation and temperature compensation with the environment has been possible. • During the acclimatisation time, do not connect the measuring device to the electric power supply. • The catalytic converter unit CATALYST for the reference gas generation system requires a pre-heating time of approx. 0.5 hours. No compressed air must flow through the METPOINT®OCV compact until this time period has expired. • This process is particularly important where there are significant temperature difference between the transport/storage location and the operating environment.

5.1 Initial switching on

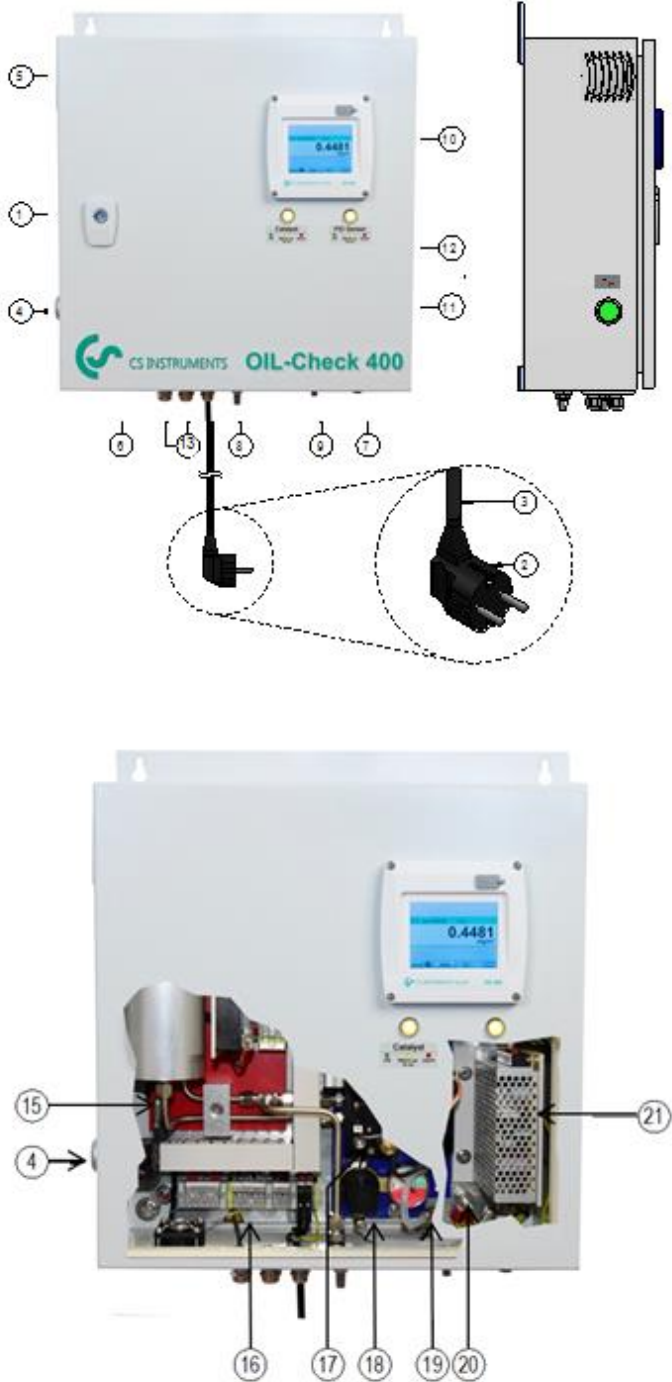

Description of the system components

- 2 Mains plug with protective contact
- 3 Electrical connection cable, 2.5 m long
- 4 Power switch for electrical power supply
- 10 Measured value display
- 11 LED-1 / operating message CATALYST
- 12 LED-2 / operating message PID sensor
- 13 Cable glands for customer electrical connections, 6 pieces M12x1.5
- 14 CATALYST, catalytic converter unit for generating zero-air
- 15 Oil and grease-free pressure regulator
- 16 Pressure gauge for measuring gas operating pressure

After the installation is completed, proceed as follows for the commissioning of the measuring device:

- 1st Ensure that the temperature equilibrium of the measuring device is connected to the ambient conditions.
- 2nd Inspect the compliance with the safety instructions for the ambient conditions. Refer to the chapter for "Assembly"
- 3rd Inspect the compliance with the safety instructions relating to the quality of the compressed air. Refer to the chapter for "Assembly"
- 4th Inspect the compliance with the safety instructions relating to the quality of the connection components. Refer to the chapter for "Assembly"
- 5th Inspect the compliance with the safety instructions for the electrical connections and the voltage supply. Refer to the chapter for "Assembly"
- 6th Plug in the power plug (2).
- 7th Turn on the power switch (4).
- 8th The warm-up phase of the CATALYST begins.

During the warm-up phase, an alarm signal sounds from the microprocessor-controlled temperature controller of the **CATALYST** unit. This alarm is also indicated by a flashing of the display (inside the device).

The acoustic and optical alarm signals are only active outside the following temperature limits: Reactor temperature $<+ 130^{\circ}\text{C}$ and reactor temperature $> + 240^{\circ}\text{C}$.



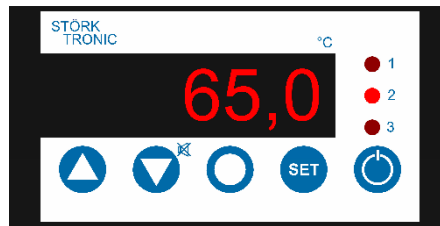





Temperature regulator of the CATALYST unit



	Pressing the function button will deactivate the acoustic alarm.
---	--

The acoustic and optical alarm signals will be automatically deactivated when the minimum operating temperature of +130°C is achieved.

- The warm-up phase for the **CATALYST** catalytic converter unit **of minimum 30 minutes** must be waited for. Two LEDs illuminate as orange in the catalytic converter warm-up phase. The PID sensor will not be perfused with compressed air in this time.

Both LEDs illuminate as orange = warm-up phase not completed.	
 Catalyst  OK  Warm-up 30 min.  Alarm	 PID Sensor  OK  Warm-up 30 min.  Alarm

The measurement value of **0.0000 mg/m³** will be indicated in the first 8 minutes of the warm-up phase of the **CATALYST** catalytic converter unit. The measurement value for the concentration of hydrocarbons in the environment will be indicated for the remaining 22 minutes. The ambient air diffuses via the outlet muffler in the measuring chamber and generates a signal voltage which equates to the hydrocarbon concentration in the environment.

If the **CATALYST** catalytic converter warm-up phase is completed, then these two LEDs illuminate as green.

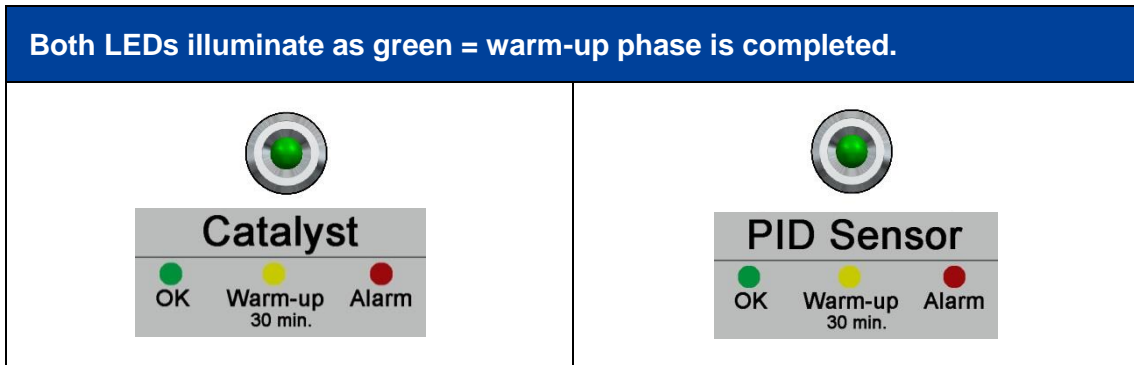

10. Open the connected compressed air supply – e.g. Ball valve Position H1 - and slowly pressurise the system.
11. Inspect the setting on the pressure regulator (18) of the oil vapour measuring device on the **OIL-Check 400**. This pressure reducer is set as default to an operating pressure of **2.50 bar(ü)**.

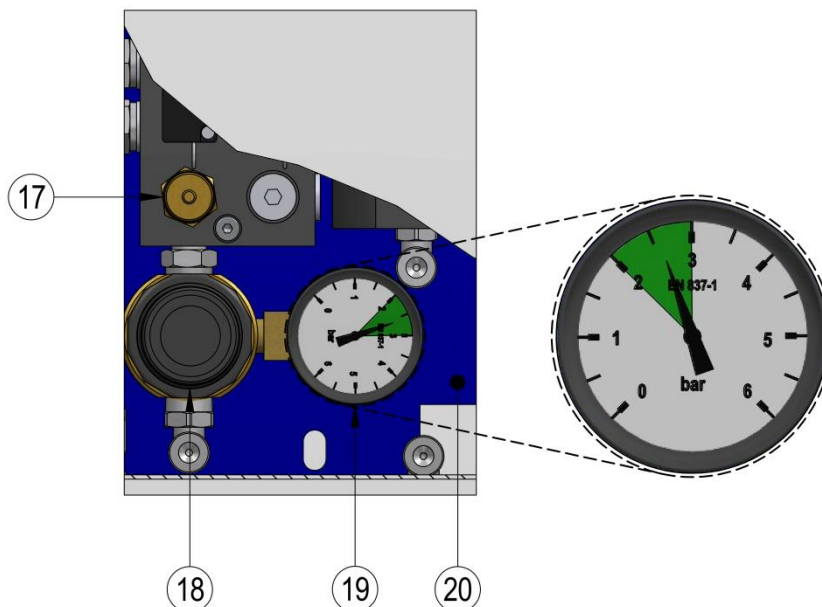

If it is necessary to change the setting of the pressure regulator, proceed as follows:

- Unlock the pressure regulator's adjustment head by pulling the hand wheel upwards.
- Release the line pressure by turning the hand wheel (18) anti-clockwise.
- Turning the hand wheel clockwise produces an increase in the initial pressure. Turning the hand wheel anti-clockwise generates a reduction in the output pressure.
- Control the pressure on the manometer of the pressure regulator.
- Lock the adjustment head of the pressure regulator by pressing the hand wheel downwards.

NOTE	Automatic calibration / Measurement values
	<p>The measuring value 0.0000 mg/m³ will be indicated in the first 8 minutes after switching on the measuring device. An automatic calibration for the zero point will be executed in this time. The first measurement value, which you can still amend, will be indicated after approx. 8 minutes.</p> <p>In the case of an initial commissioning, the measurement value will be initially stable after approx. 90 minutes when the device is located in thermal equilibrium.</p>

6 Troubleshooting and remedying malfunctions

6.1 Measures in emergencies



In case of emergency, switch off the **OIL-Check 400** via the mains power switch for electrical power supply (4) and unplug the power supply plug (2).

WARNING!	Fighting fires
	<p>Never utilise water for fighting fires on or close to the OIL-Check 400.</p>

6.2 Operating messages

The operating statuses of the individual components are permanently monitored and signalled by means of LEDs. A potential-free changeover contact provides the possibility of forwarding the operating messages.



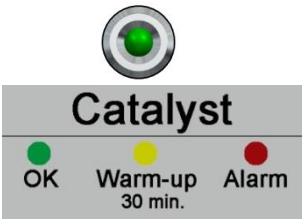
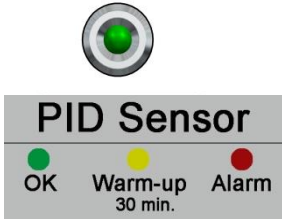
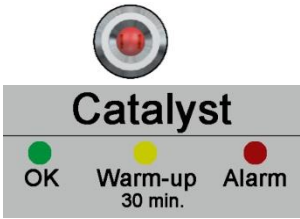
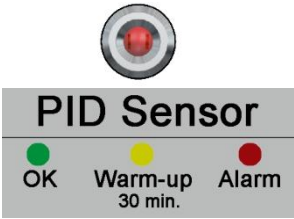

Operating message CATALYST	Operating message PID sensor
<p>A green LED indicates the malfunction-free operation of the catalytic converter unit for the generation of zero-air, the so-called CATALYST.</p>	<p>A green LED indicates the interference-free operation of the PID sensor.</p>
	
<p>In the event of a malfunction of the CATALYST, the LED switches from GREEN to RED.</p>	<p>In case of a PID sensor operational malfunction, the LED switches from GREEN to RED.</p>
	
<p>If a deviation from the defined parameters is detected in the monitoring software, then the programme switches over to safe operation and switches off the compressed air supply to the PID sensor. The alarm status will be signalled by the red LED of the corresponding LED and a potential-free changeover contact switches.</p>	

The following operating statuses will be monitored and issued as a malfunction:

- Operating pressure in the system
- Measuring gas through flow rate
- Operating temperature for the catalytic converter unit
- Measuring gas temperature in the sensor chamber
- Measuring gas pressure in the measuring chamber
- EPCB temperature
- UV lamp failure
- Measuring range
- Exceeding the maintenance interval

Malfunction image	
	
Cause	Measure
<p>Operating temperature for the catalytic converter unit is too low.</p> <p>Operating temperature of the catalytic converter unit is too high as a result of a too high oil content.</p> <p>Temperature regulating settings have been amended.</p> <p>Compressed air humidity is too high.</p>	<p>Inspect measuring gas flow-through.</p> <p>Inspect operating pressure.</p> <p>Inspect pressure regulator setting on compressed air INLET.</p> <p>Inspect pressure dew point.</p>

Malfunction image	
 <div style="border: 1px solid gray; padding: 5px; display: inline-block;"> <p style="margin: 0;">PID Sensor</p> <p style="margin: 0;"> ● OK ● Warm-up 30 min. ● Alarm </p> </div>	
Cause	Measure
<p>UV lamp is defect.</p> <p>Measuring gas temperature is too high.</p> <p>Oil content in the compressed air is too high.</p> <p>EPCB temperature is too high.</p> <p>Measuring gas pressure in the PID measuring chamber is too high.</p> <p>Operating pressure on compressed air INLET too low.</p>	<p>Inspect measuring gas flow-through.</p> <p>Inspect operating pressure.</p> <p>Inspect pressure regulator setting on compressed air INLET.</p> <p>Exchange UV lamp.</p> <p>Inspect compressed air supply.</p>

Malfunction image: Red flashing of both these LEDs	
 <div style="border: 1px solid gray; padding: 5px; display: inline-block;"> <p style="margin: 0;">Catalyst</p> <p style="margin: 0;"> ● OK ● Warm-up 30 min. ● Alarm </p> </div>	 <div style="border: 1px solid gray; padding: 5px; display: inline-block;"> <p style="margin: 0;">PID Sensor</p> <p style="margin: 0;"> ● OK ● Warm-up 30 min. ● Alarm </p> </div>
Cause	Measure
<p>Maintenance interval (8,760 operating hours) was exceeded.</p>	<p>Execute maintenance and recalibration.</p>

6.2.1 Exceeding and undershooting the CATALYST temperature

If the **CATALYST** temperature is located outside the following temperature limits:
< +130°C and > +240°C, then an alarm signal from the microprocessor-controlled temperature regulator will be issued. This alarm will also be indicated by flashing display.

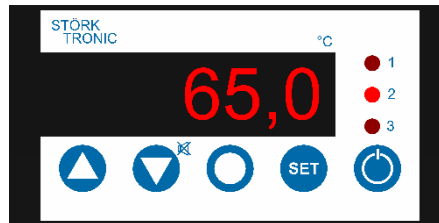

	Pressing the function button will deactivate the acoustic alarm.
---	--

7 Maintenance and repair works

The owner or operator of the **OIL-Check 400** must ensure that the measuring device is inspected in a satisfactory manner, regularly monitored and repaired.

All servicing, maintenance and repair works may only be executed by specially trained, skilled personnel and/or professional qualified companies.

DANGER!	Electric power
	<p>Touchable conductive parts can lead to dangerous voltages / mains voltage during installation and maintenance or in case of defects. Hazard resulting in of serious or even fatal injury from electric shock when coming into contact with uninsulated parts or mains voltage.</p> <ul style="list-style-type: none"> • All works on the electrical parts of the measuring system may only be executed by appropriately trained skilled personnel. • The measuring device must not be operated when the power supply cables indicate damage or the housing parts have been damaged or removed. • The local valid legal regulations and provisions must be complied with without exception. • Observe the electrical data provided on the rating plate. • Work on the electrical connections may only be executed when the power supply is switched off. The device must be protected against unintentional reconnection or switching on again. • Only utilise components for the electrical installation which have a current approval and are labelled with a CE-Identification Marking. • The wire ends to be connected to the control unit must be equipped with wire-end ferrules. • All electrical connections must be inspected before commissioning and at regular intervals.

- **Maintenance and repair works must be executed in such a way that:**
- Accidents for people are prevented
- Damage to quality is prevented
- The components of the measuring system remain in a good operating condition
- The intended use and utilisation capability of the system remain unaffected.

CAUTION	Error functions on the OIL-Check 400
	<p>Incorrect installation and insufficient maintenance can lead to malfunctions on the measuring device which will impair the display functions and could lead to incorrect interpretation.</p> <p>Observe the applicable national regulations, provisions and safety regulations during installation and operation.</p>

7.1 Advance and subsequent preparation for maintenance works

- **Disconnect the device from the power supply. Unplug the power cable to disconnect the device.**
- **Secure the device against unintentional reconnection.**
- **Prepare the ESD protection as described below.**

7.1.1 Prevention of electrostatic discharge (ESD)

DANGER!	Damage is possible due to electrostatic discharge ESD
	<p>The measuring device contains electronic components that might be destroyed by electrostatic discharge (ESD). Contact with people or objects that are electrically charged endangers these components. In the worst case, components sensitive to ESD might be instantly destroyed when touched or fail after start-up.</p> <p>In order to minimise or prevent possible damage from sudden electrostatic discharge, observe the requirements of EN 61340-5-1. Always therefore ensure that you do not touch electronic components while they are connected to voltage or power supplies.</p>

Basic safety precautions

In order not to cause damage when handling electronic devices, take the necessary precautions for the prevention of electrostatic charges as laid down in DIN EN 61340-5-1, IEC 63140-5, and DIN EN 100 015. These precautions prevent electronic discharge from being caused and the associated damage to your equipment.

Measures

As soon as the housing of the **METPOINT® OVC compact** is opened for maintenance or servicing, the following protective measures must be implemented and the corresponding safety resources must be utilised.

Utilise an earthed ESD mat

Wear a wrist strap

Discharge tools prior to use by rubbing them over the ESD mat

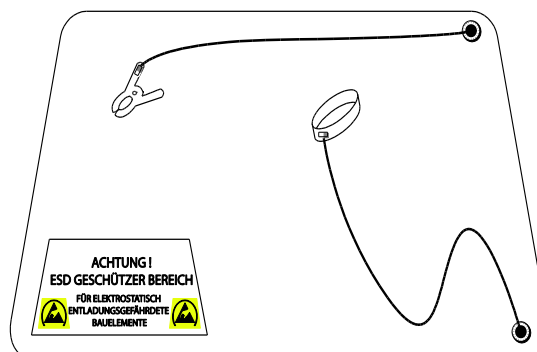

7.2 Retaining the protection class with a housing

The measuring instrument **OIL-Check 400** fulfils the requirements of protection class **IP 54** according to EN 60529.

The protection class of a housing is defined by the IP mark and a two-digit code number. The first digit has two meanings (protection for people and operating material or resources), the second digit has only one meaning: Protection against water.

IP 54 according to EN 60529

IP International Protection

- 5 Dust-protected, dust deposits are permissible, but they may not endanger the function of the device with their quantity
- 4 Protected against splashing water, water which splashes from any direction against the housing must not have any harmful effect.

CAUTION	Risk of damage to device
	<p>After all assembly, service and maintenance works on the measuring instrument, the specified protection class has to be ensured again.</p>

When executing any types of work on the **OIL-Check 400**, the following points must always be adhered to:

- Use only clean original seals Replace defective seals.
- The electrical connection cables used must not indicate any damaged. The cables must fulfil the requirements of relevant standards and regulations. Replace faulty cables immediately.
- Lay the cables in front of the measuring device as a loop to prevent water ingress into the housing.
- Tighten the cable gland openings tightly.
- Close unused cable glands with a blind plug.

The **OIL-Check 400** measuring instrument fulfils the requirements of protection class **IK 08** according to **IEC 62 262** against external mechanical stresses.

7.3 Maintenance schedule

This submitted maintenance schedule is considered to be a recommendation from the manufacturer. The owner or operator must check the intervals depending on the operating conditions and, if necessary, shorten the intervals.

Activity	Weekly	Monthl y	Annual y
Inspect the pressure on the manometer of the pressure regulator	x		
Inspect the measuring system externally for soiling, damage and corrosion		x	
Record current operating parameters and compare them with the data in "Technical data"		x	
Inspect the safety equipment and devices			x
Inspect pipework connections and all bolt and screw connections and tighten as necessary			x
Inspect the terminals of the electrical installation and re-tighten if necessary			x
Execute a leak test on the system			x
Functional inspection of the electrical switching and control devices			x
Inspect fuses and replace if necessary			x
Inspect the function and wear of the solenoid valves			x
Inspect the function and condition of the compressed air regulator			x
Execute a function test for the operating messages			x
Inspect the functions of the catalytic converter unit CATALYST			x
Inspect the electrical connection for damage		x	
Replace the UV lamp of the PID sensor			x
Carry out the cleaning of the PID sensor chamber			x
Inspect sensor sensitivity			x
Calibrate / adjust the PID sensor			x

7.4 Calibration intervals

The user is solely responsible for setting the calibration intervals.

If specifications are provided for recalibration, e.g. in the quality management manual, then these are the binding source for recalibration periods.

If the QM system does not contain any specifications concerning the calibration periods, then the decision must be taken from weighing up how much the costs are for a more frequent recalibration on the one hand and, on the other hand, for possible invalid results.

For certain measurement conditions such as e.g. high operating hours (shift operation), extreme temperature conditions, continuous alternating current operation, dirt and moisture, a more frequent calibration is required.

The importance of the operating conditions will also mean that recalibration must always be implemented when the **OIL-Check 400** is exposed to loads and stresses which exceed the intended use. This can range from increased overload or falling down, extreme temperature conditions, high humidity levels of the compressed air up to, and including, accessing the device for repair purposes.

In the case of very high demands on the accuracy of the measurement, we recommend to provide an interval for recalibration of 6 months. If, after the first or second recalibration, the measurement properties remain stable, then the calibration interval can be extended to 12 months. A corresponding method for the adaptation (extension or shortening) of the calibration intervals should be part of the QM system.

A recalibration must be executed 12 months after delivery of the OIL-Check 400 at the latest.

The LEDs installed below the display:

"**CATALYST Operation**" and "**PID Sensor Operation**" indicate to the user that a maintenance / calibration of the measuring device is necessary. The two LEDs flash as red every 24 seconds for 4 seconds (flashing frequency of 200 ms) after **8,760 hours of operation**.

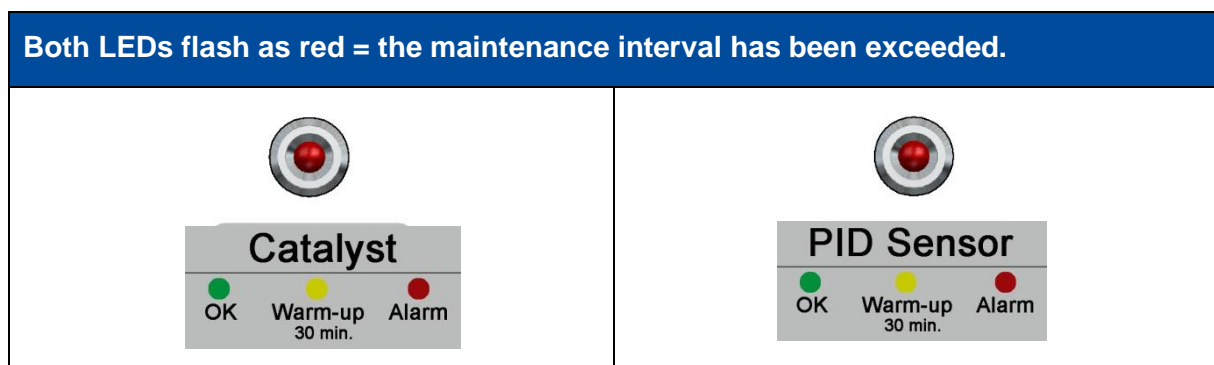

7.5 Inspect the pressure regulator for the compressed air inlet

There is a pressure reducer (18) for the compressed air located inside the housing of the **OIL-Check 400**. This pressure reducer is used to regulate the pressure of the measurement gas and is set at an operating pressure of approx. 2.5 bar (ü) as default.

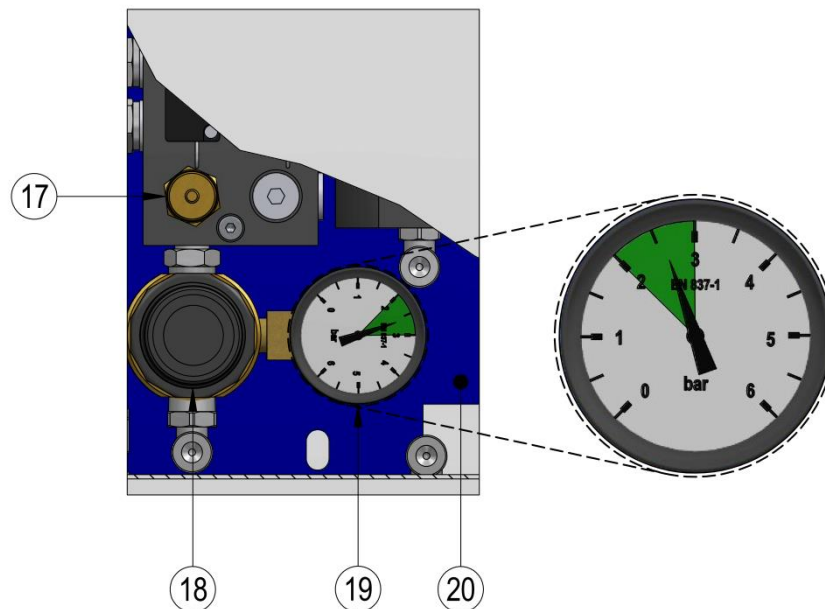

- 17 Safety valve for the measuring gas components
- 18 Oil and grease-free pressure regulator
- 19 Pressure gauge for measuring gas operating pressure
- 20 Sensor module including solenoid valves, pressure switch, PID sensor and pressure regulator

If it is necessary to change the setting of the pressure regulator, proceed as follows:

- Unlock the pressure regulator's adjustment head by pulling the hand wheel upwards.
- Release the line pressure by turning the hand wheel (18) anti-clockwise.
- Turning the hand wheel clockwise produces an increase in the initial pressure. Turning the hand wheel anti-clockwise generates a reduction in the output pressure.
- Control the pressure on the manometer of the pressure regulator.
- Lock the adjustment head of the pressure regulator by pressing the hand wheel downwards.

7.6 Electrical connection cable defective

When the mains power supply cable is damaged, then the system must be immediately shut down. It may only be put into operation again after the mains cable has been replaced.

Replace a damaged power cable immediately.

Only replace a damaged mains power cable with an equivalent cable.

NOTE	Mains voltage
	The required supply voltage is: 100-240 VAC / 1Ph. / PE / 50-60 Hz / ± 10%

Technical specification of the electrical connection cable supplied with the measuring instrument:

Mains cable feed	
Power cable:	3 x 0.75 mm ² with protective contact plug and PE protection earthing
Plug connector:	Two pin plug connector with safety contact
Nominal voltage plug	250 V
Nominal current plug	16 A,
Standard plug connector:	Production guideline CEE 7 Standard sheet VII, VDE 0620
Cable length and type	2.5 m, cable type H05VV-F 3G0.75 Connection cable according to harmonised documents: HD21.5, HD21.12 (VDE 0281-5, VDE 0281-12)

The cable is compliant with (EC) Ordinance No. 1907/2006 (REACH) and EC Directive 2011/65/EC (RoHS) as well as the EC Low Voltage Directive 2014/35 / EU.

7.7 Replacing the fuses

The device is fused on the primary side with two fuses of **2.5 A load**. These are located in the fuse holders of terminals **X24: L** and **X24: N**.

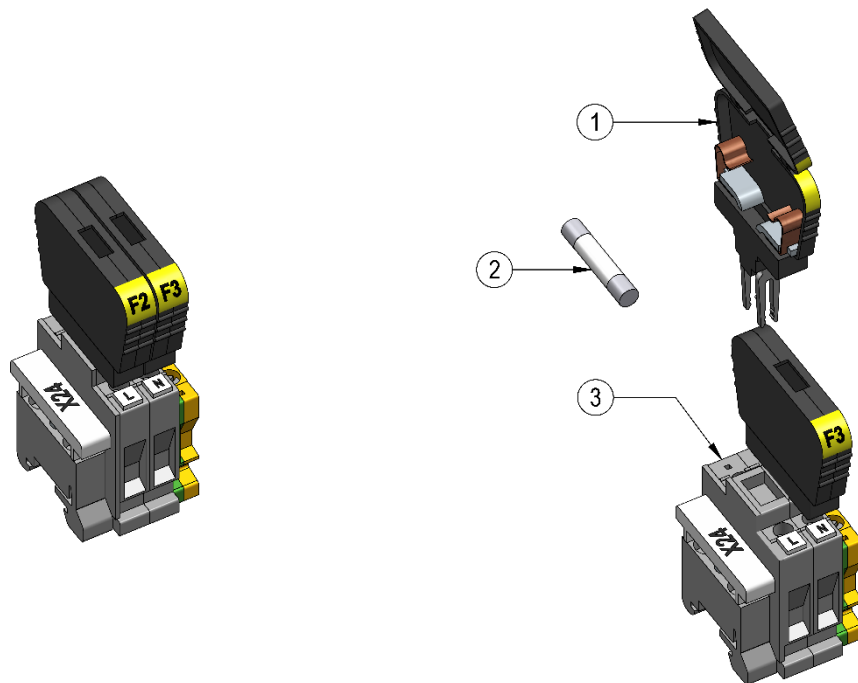

- 1 Fuse holder
- 2 Fuse unit
- 3 Fuse terminal

Internal device security	
Fuse unit:	5 x 20 mm
Diameter:	Ø 5 mm
Length:	20 mm
Structure:	Ceramic pipe with extinguisher
Contact caps:	Brass nickel-plated
Type:	T2, 5AH
Voltage:	250 V AC
Shut down characteristics:	Sluggish
Rated current:	2.5 A
Switching capacity	1500 A (H)
Fuse unit:	EN 60127-2-5

The device is protected on the secondary side with a **1.5 A medium-time** fuse. This is located in a fuse holder on the control board and is marked with **F1**.

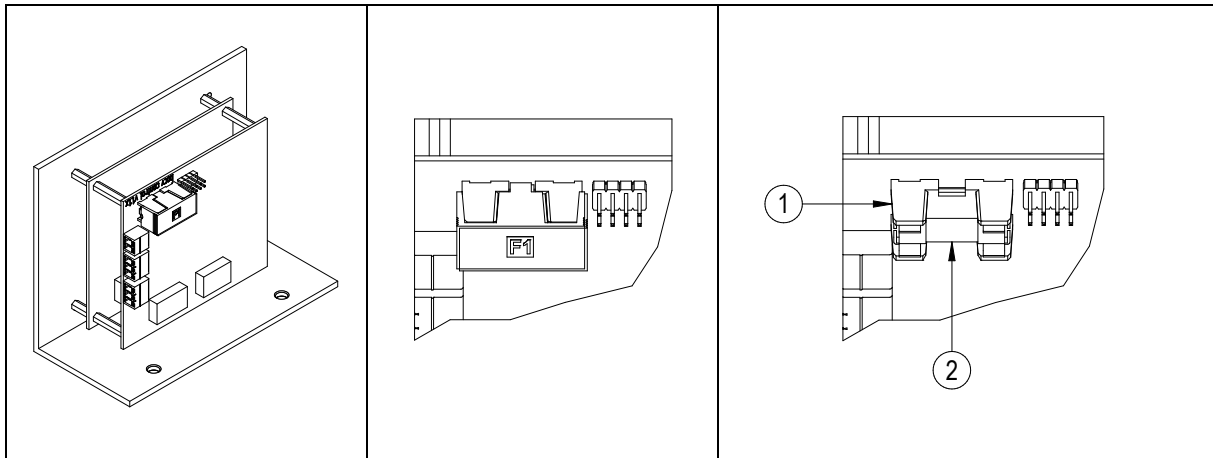

- 1 Fuse holder
- 2 Fuse unit

Internal device security	
Fuse unit:	5 x 20 mm
Diameter:	Ø 5 mm
Length:	20 mm
Structure:	Glass tube, transparent
Contact caps:	Brass nickel-plated
Type:	T1, 5AM
Voltage:	250 V AC
Shut down characteristics:	Medium-time
Rated current:	1.5 A
Switching capacity	100 A
Fuse unit:	UL/CSA 248-14

7.8 Cleaning and decontamination

Cleaning the **OIL-Check 400** will be executed with a slightly damp (not wet) cotton cloth or disposable wipe as well as mild, conventional cleaning agents/soap.

To decontaminate the device, spray the cleaning agent on a clean cotton cloth or disposable wipe and thoroughly wipe the device. Dry the device subsequently with a clean cloth or let it dry at room temperature. Observe the locally applicable hygiene regulations.

CAUTION	Risk of damage to device
	Excessive humidity, the use of hard and pointed objects and aggressive cleaning agents can cause damage to the measuring system and the integrated electronic components. Observe the applicable national regulations, provisions and safety regulations during installation and operation.

Measures

- Never clean dripping wet
- Do not use aggressive cleaning agents
- Do not clean the device with hard or pointed objects

7.9 List of spare parts

Replacement of spare parts may only be executed by CS Instruments GmbH & Co. KG.

Product number	Description
4040007	<p>Module: CATALYST Catalytic converter unit for generating zero-air. Completely assembled and programmed.</p>
4040008	<p>Module: Measurement gas block Including: Solenoid valve, pressure vessel, PID sensor with measuring chamber, sensor board with AD converter, new UV lamp, new characteristic curve, pressure regulator with manometer. Completely assembled for connection and programmed, 10 point calibration with calibration log.</p>
4040006	<p>Muffler, material: Brass nickel-plated, Connection: G1/8" external thread.</p>

8 Decommissioning and Disposal

8.1 Decommissioning

Disconnect all electrical components of the **OIL-Check 400**.

Turn off the power switch (Position 4).

Unplug the power cord.

Close the compressed air supply.

Close the shut-off ball valve item H1.

8.2 Disposal

Disposal of the device according to the WEEE Directive (Waste Electrical and Electronic Equipment)

Electrical and electronic components (WEE) must not be disposed as normal household waste in municipal rubbish bins. To dispose of the product, dismantle it. Materials such as glass, plastics and some chemical compounds are, recoverable, reusable, or recyclable.

According to Clause 5, Section 1 of the German Electrical and Electronic Equipment Act (ElektroG), **OIL-Check 400** is classified in Category 9 and not subject to any restrictions regarding hazardous substances. According to Clause 9, Sentence 7 (ElektroG), the **OIL-Check 400** is will be taken back by CS Instruments GmbH & Co. KG for disposal.

If the **OIL-Check 400** is not returned to CS Instruments GmbH & Co. KG for disposal, then **waste disposal key 20 01 36** will apply for used electrical and electronic equipment other than those mentioned in 20 01 21, 20 01 23 and 20 01 35.

WARNING!	Risk to health and the environment!
	<p>Never dispose of old devices as normal household waste!</p> <p>Depending on the medium utilised in the system, residues in the system could cause a hazard for the health of the operator and the environment. Always therefore implement suitable protective measures and dispose of the system through the proper channels accordingly.</p>

Measures:

Dismantled components must be immediately freed of measuring material residues when suitable measures have not been implemented previously.

